

TV FLOOR STAND

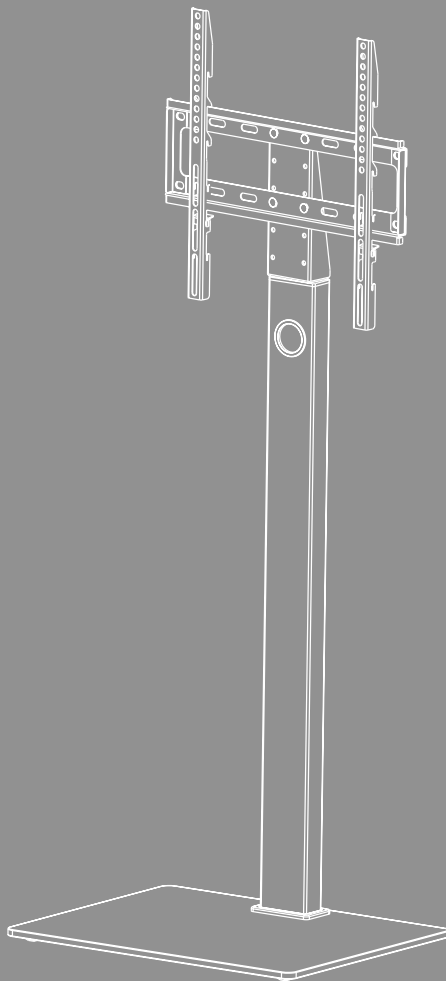



Contents

1. Explanation of warning symbols and notes	3
2. Package contents	4
3. Additionally required tools	4
4. Safety instructions	5
5. Application and specifications	5
6. Preparation and assembly	6
6.1 Assembly preparation	7
6.1.1 Attaching the rubber feet	7
6.1.2 Mounting the mounting pillar on the base plate	7
6.1.3 Fitting the mounting joint and mounting plate	8
6.2 Mounting on the TV set	9
6.2.1 Mount the VESA arms on the back of the TV set	10
6.3 Mounting the TV on the TV floor stand	11
6.4 Cable management	12
7. Adjustment & maintenance	13
8. Setting options	14
9. Technical data	15
10. Warranty disclaimer	16
11. Service and support	16
12. Warranty conditions	16



GB Operating Instructions

Thank you for choosing a Hama product.

Take your time and read the following instructions and information completely. Please keep these instructions in a safe place for future reference. If you sell the device, pass on the illustrated quick start guide and the safety instructions in printed form to the new owner.

1. Explanation of warning symbols and notes

Warning



This symbol is used to indicate safety instructions or to draw your attention to specific hazards and risks.

Note

























This symbol is used to indicate additional information or important notes.



2. Package contents

- TV bracket
- VESA arms (2x)
- Mounting pillar
- Base plate
- Mounting kit
- Safety instructions, illustrated quick start guide

Mounting kit					
A1		M10 (x2)	D1		M8x12 (x4)
A2		M10 (x1)	D2		M8x20 (x4)
A3		M6x12 (x4)	D3		M8x30 (x4)
A4		M8x25 (x3)	D4		M8x50 (x4)
A5		M8 (x3)	E1		M4x12 (x4)
A6		M6 (x4)	E2		M4x20 (x4)
A7		M10 (x1)	F1		(x4)
B1		M6/M8 (x4)	F2		(x2)
B2		M8x10 (x4)	F3		(x1)
B3		M8x20 (x4)	F4		(x1)
C1		M6x12 (x4)	F5		(x1)
C2		M6x20 (x4)			

* M8x50 + Ø 8x5 = M8x45

Note

Please check the mounting kit for completeness before installing the bracket and ensure that there are no faulty or damaged parts.

3. Additionally required tools



Note

Never install the bracket alone. Seek assistance and help!



4. Safety instructions

Warning



- Given the multitude of terminal devices and wall structures available on the market, the supplied mounting kit is unable to cover every option.
- It occasionally happens that the screws for attaching the device to the bracket are too long.
- Read the operating instructions for your terminal device before attempting to mount it. The instructions provide information about the type and measurements of suitable fastening materials.
- If the supplied mounting kit does not contain suitable fastening materials for mounting the terminal device, purchase these from a specialised dealer.
- Never apply force during assembly. This can damage your device or the holder.
- If in doubt, have this product installed by a qualified technician - do not attempt to install it yourself!
- Once you have mounted the product and the attached load, check that they are sufficiently secure and safe to use.
- You should repeat this check at regular intervals (at least every three months).
- Ensure that the product does not exceed its maximum permitted carrying capacity and that no load exceeding the maximum permitted dimensions is attached.
- Make sure that the product is loaded symmetrically.
- Maintain the necessary safety clearance around the attached load (depending on the model).
- In the event of damage to the product, remove the attached load and stop using the product.
- Do not attach any additional objects to the product.

5. Application and specifications

- The bracket is used for mounting flat screens in private, non-commercial households.
- The bracket is intended only for use inside buildings.
- Use the bracket only for the intended purpose.



6. Preparation and assembly

Note





- Never install the bracket alone. Seek assistance and help!
- Different end devices have different connections for cabling and other devices. Before commencing the installation, check whether the necessary connections can still be reached after mounting.
- Depending on the product and mounting method, you may not need all parts of the mounting kit. It is therefore possible that unneeded screws and other small parts will be left over even after correct mounting. Keep these in a safe place together with these operating instructions for use for later reference (sale of the product, moving house, relocation of the bracket, new TV, etc.).

Warning



- Only set the product up on even, non-slip surfaces with a sufficient load-bearing capacity for the product and the device attached to it.
- Make sure that children do not use the product for climbing.
- Note that the castors of the product can cause pressure marks on the installation surface. This depends on the weight loading and on the stability of the surface at the place of installation.
- Please note that subsequent height adjustment is only possible by dismantling the suspension fitting.



6.1 Assembly preparation

6.1.1 Attaching the rubber feet

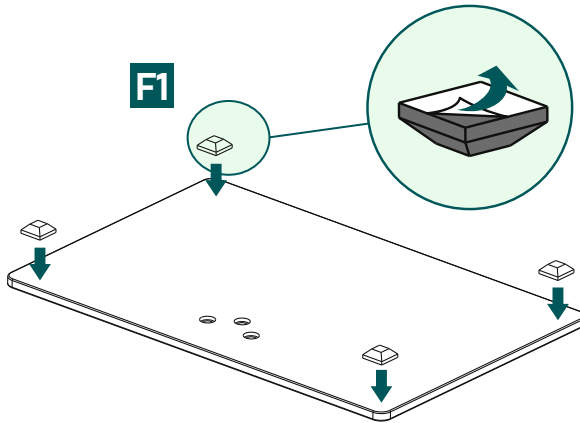

- Attach the self-adhesive rubber feet [F1] to the corners of the base plate as shown above.

6.1.2 Mounting the mounting pillar on the base plate

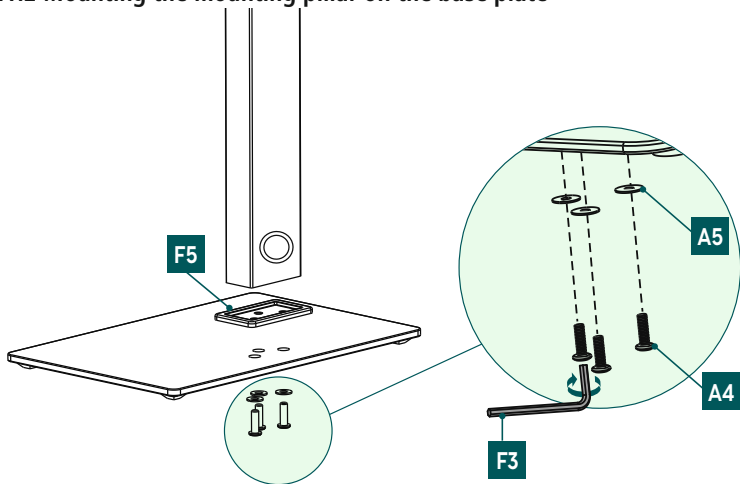

- Connect the mounting pillar and the base plate using the connecting piece [F5].
- Finally, secure the individual parts with the washers [A5] and the screws [A4]. Use the Allen key [F3] to do this.



6.1.3 Fitting the mounting joint and mounting plate

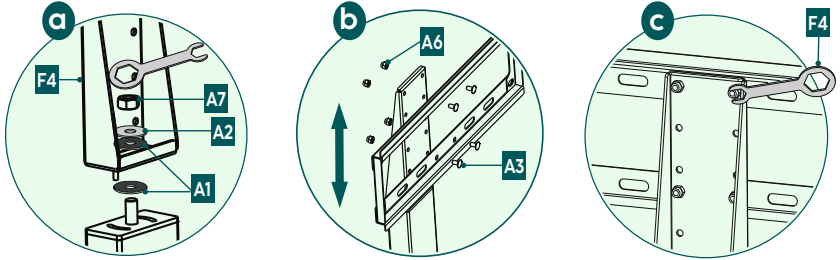



a

Connect the mounting pillar and the mounting joint to each other. Note that the washer [A1] must be positioned between the two components. Secure the mounting joint with the washers [A1], [A2] and the screw nut [A7]. Use the hexagon ring spanner [F4].

b + c

Position the mounting plate at the desired height. Secure it with the screw [A3] and the screw nut [A6] using the hexagon ring spanner [F4].



6.2 Mounting on the TV set

Note

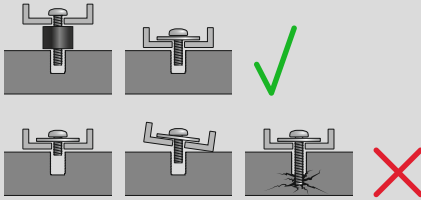

- Given the multitude of terminal devices structures available on the market, we cannot describe all possible mounting options here.
- Please ensure that the bracket lays flat and evenly on the back of the television.
- Use the enclosed spacer to even out any unevenness on the back of the television.
- Ensure that all screws have the proper length and can be mounted until they are hand-tight.



6.2.1 Mount the VESA arms on the back of the TV set

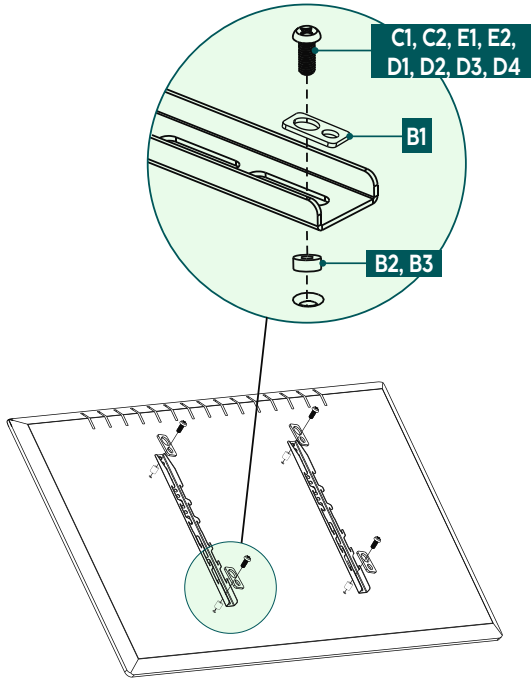

Flat TV back

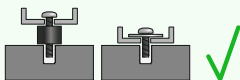
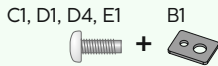

Curved TV back

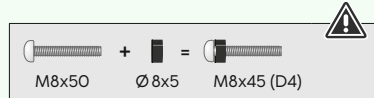
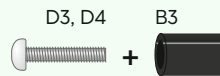
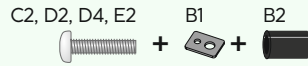

- Mount the VESA arms the back of your TV set.
- Use the fold-out VESA arms to mount the TV at the desired height.
- Ensure that the VESA arms are correctly aligned. The two hooks must point downwards.
- Note the combination of screw, washer and spacer listed above for your flat or curved TV.



6.3 Mounting the TV on the TV floor stand

Get support and help from other people for the following assembly step.

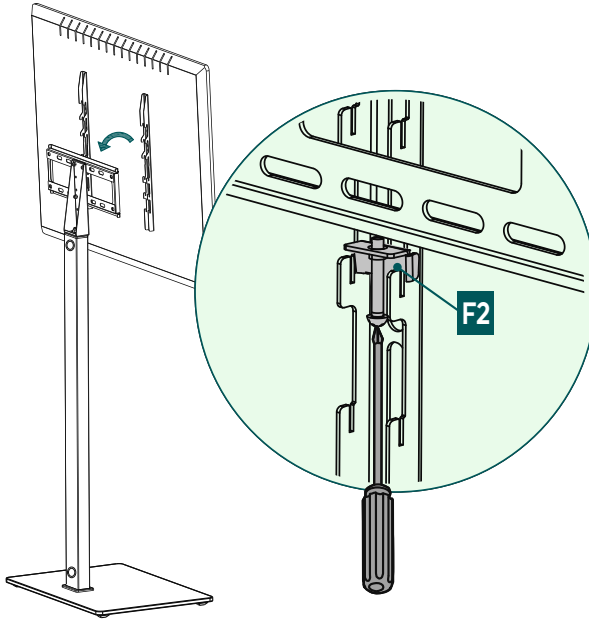
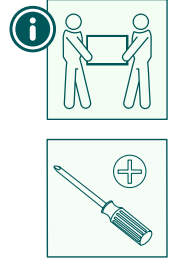

- Hang the TV set with the mounted VESA arms on the bracket as shown above. Select one of the three levels for the desired height adjustment of the flat screen.
- Lock the safety device [F2] by tightening the screws.



6.4 Cable management

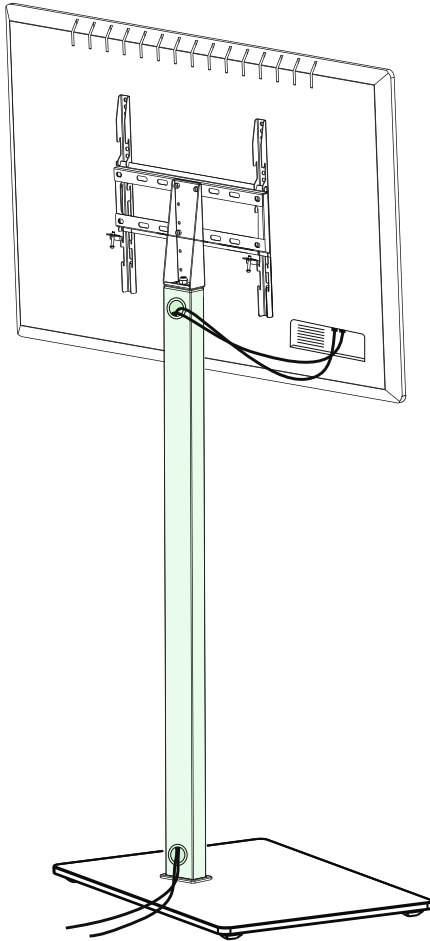

- Use the openings on the mounting pillar for cable management.



7. Adjustment & maintenance

Note



Never adjust the bracket alone. Seek assistance and help!

Note - tiltable / full-motion brackets



- Ensure that no electrical cables are crushed or damaged during installation or adjustment.
 - During adjustment, ensure that the product is loaded symmetrically and that the maximum permitted carrying capacity is not exceeded.
-
- Check the strength and operational safety of the bracket and the load attached to it at regular intervals (at least quarterly).
 - Clean only with water or conventional household cleaners.

8. Setting options

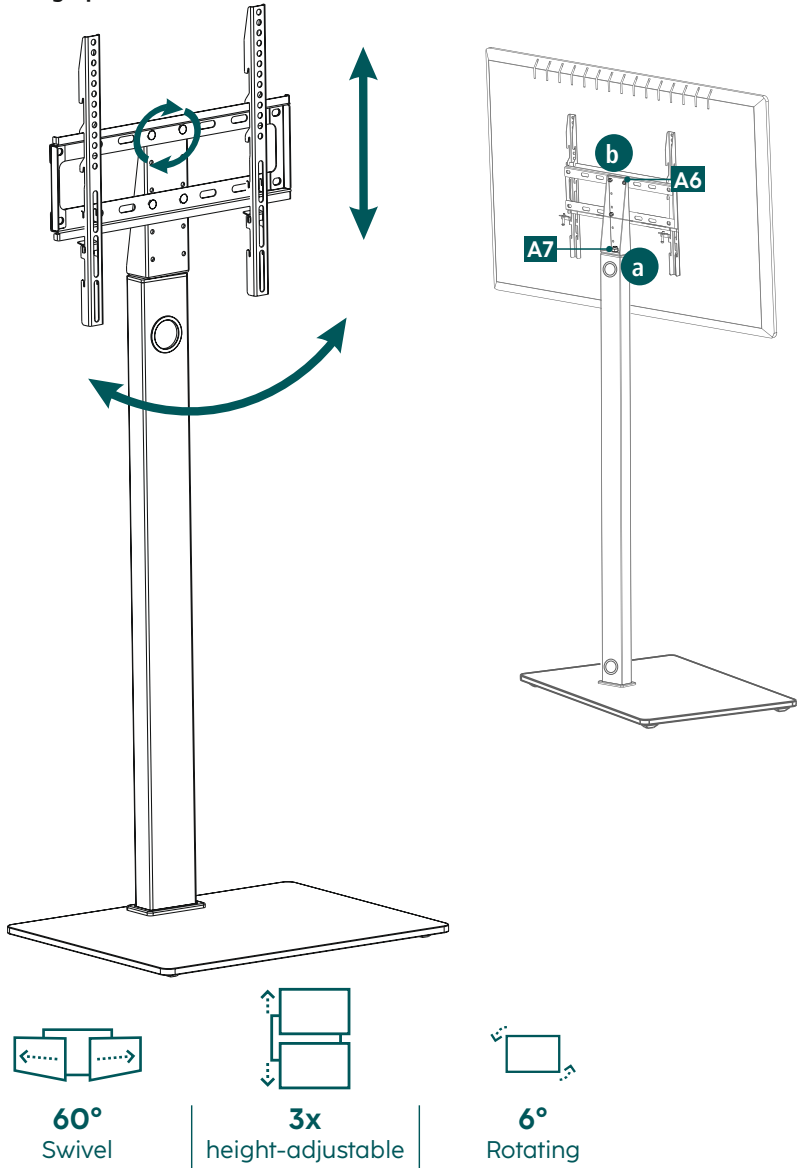

- If the turning function is stiff, loosen the nut [A7] on the joint slightly (see Fig. a).
- If the horizontal alignment of your TV set needs to be subsequently adjusted on the TV plate, loosen the screw nuts [A6] (see Fig. b). They must then be tightened again to secure them.



9. Technical data

Maximum load:	35 kg
Screen diagonal:	81.0 - 165.0 cm (US: 32" - 65")
Height of centre point of TV plate:	110 cm
Swivel range:	up to 60° (depending on device)
Base plate dimensions:	50 x 50 cm
Mount:	Compliant with VESA standard: 100 x 100 100 x 200 200 x 100 200 x 200 200 x 300 300 x 100 300 x 200 300 x 300 300 x 400 400 x 200 400 x 300 400 x 400



10. Warranty disclaimer

Hama GmbH & Co KG assumes no liability and provides no warranty for damage resulting from improper installation/mounting, improper use of the product or from failure to observe the operating instructions and/or safety notes.

11. Service and support

Please contact Hama Product Consulting if you have any questions about this product.

Hotline: +49 9091 502-0 (German/English)

Further support information can be found here: www.hama.com

12. Warranty conditions

For this product, HAMA GmbH & Co KG grants you an extended manufacturer's warranty for freedom from defects, usability, workmanship and the durability of the materials used for a period of 10 years. Excluded from the guarantee is the compatibility of the product with future standards of further developed hardware.

Within the specified period, Hama GmbH & Co KG will remedy a justified warranty claim at its own discretion, free of charge, either by repair or replacement.

The warranty period begins on the date of purchase of this product and is valid throughout the EU.

The warranty granted is in addition to and does not affect your statutory rights. Damage caused by improper use, normal wear and tear, exposure to chemicals or force majeure, as well as tampering or repairs by you or third parties, are excluded from the warranty.

Furthermore, accessories that are not part of the basic equipment of the product (promotional parts) are excluded from the warranty.

In the event of a warranty claim, please contact us at Hama GmbH & Co KG, Dresdner Str. 9, 86653 Monheim, Germany, enclosing proof of purchase. You are also welcome to contact us at www.hama.de or by phone on +49 (0)9091/502-0.