

TV WALL BRACKET

Fullmotion

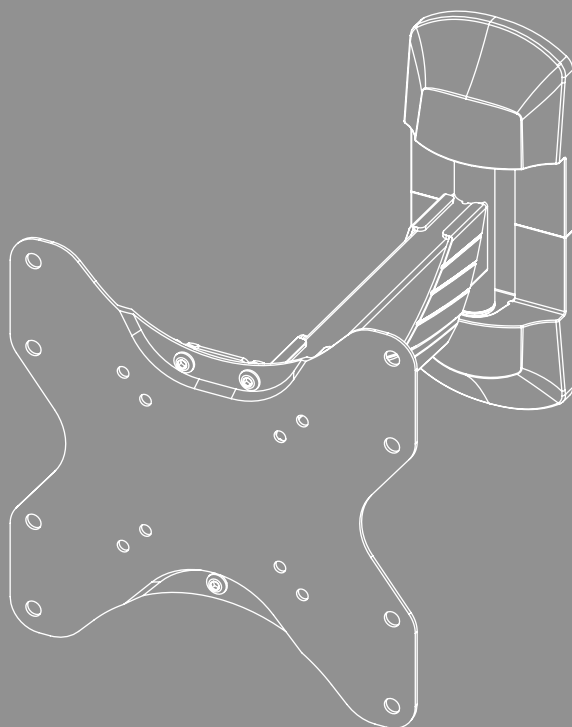



Contents

1. Explanation of warning symbols and notes	3
2. Package contents	4
3. Additionally required tools	4
4. Safety instructions	5
5. Application and specifications	5
6. Preparation and assembly	6
6.1 Assembly preparation	7
6.2 Mounting on the wall	8
6.2.1 Preparing the intended mounting surface	8
6.2.2 Attaching the wall bracket	9
6.3 Mounting on the TV set	10
6.3.1 Mounting the VESA plate on the back of the TV set	10
6.4 Mounting the TV on the wall bracket	12
6.5 Mounting the cable manager	13
7. Adjustment & maintenance	13
8. Setting options	14
9. Technical data	15
10. Warranty disclaimer	16
11. Service and support	16
12. Warranty conditions	16



GB Operating Instructions

Thank you for choosing a Hama product.

Take your time and read the following instructions and information completely. Please keep these instructions in a safe place for future reference. If you sell the device, pass on the illustrated quick start guide and the safety instructions in printed form to the new owner.

1. Explanation of warning symbols and notes

Warning



This symbol is used to indicate safety instructions or to draw your attention to specific hazards and risks.

Note



















This symbol is used to indicate additional information or important notes.



2. Package contents

- TV wall bracket
- Wall plate cover (2x)
- Cable manager (1x)
- Mounting kit
- Safety instructions, illustrated quick start guide

Mounting kit

A1		8x60 (x3)	D1		M8x12 (x4)
A2		Ø10x60 (x3)	D2		M8x20 (x4)
A3		M8 (x3)	D3		M8x30 (x4)
B1		M6 (x4)	E1		M4x12 (x4)
B2		Ø8x10 (x4)	E2		M4x20 (x4)
B3		Ø8x20 (x4)	E3		M4x45 (x4)
C1		M6x12 (x4)	F1		(x1)
C2		M6x20 (x4)	F2		(x1)

Note

Please check the mounting kit for completeness before installing the bracket and ensure that there are no faulty or damaged parts.



3. Additionally required tools



Note

Never install the bracket alone. Seek assistance and help!





4. Safety instructions

Warning



- Given the multitude of terminal devices and wall structures available on the market, the supplied mounting kit is unable to cover every option.
 - It occasionally happens that the screws for attaching the device to the bracket are too long.
 - Please note that the supplied wall plugs are for use with solid, hollow and board construction materials only.
 - Read the operating instructions for your terminal device before attempting to mount it. The instructions provide information about the type and measurements of suitable fastening materials.
 - If the supplied mounting kit does not contain suitable fastening materials for mounting the terminal device, purchase these from a specialised dealer.
 - Never apply force during assembly. This can damage your device or the holder.
 - If in doubt, have this product installed by a qualified technician - do not attempt to install it yourself!
-
- Do not mount the product above locations where persons might sit or stand.
 - Once you have mounted the product and the attached load, check that they are sufficiently secure and safe to use.
 - You should repeat this check at regular intervals (at least every three months).
 - Ensure that the product does not exceed its maximum permitted carrying capacity and that no load exceeding the maximum permitted dimensions is attached.
 - Make sure that the product is loaded symmetrically.
 - Maintain the necessary safety clearance around the attached load (depending on the model).
 - In the event of damage to the product, remove the attached load and stop using the product.
 - Do not attach any additional objects to the product.

5. Application and specifications

- The bracket is used for mounting flat screens in private, non-commercial households.
- The bracket is intended only for use inside buildings.
- Use the bracket only for the intended purpose.



6. Preparation and assembly

Note



- Never install the bracket alone. Seek assistance and help!
- Different end devices have different connections for cabling and other devices. Before commencing the installation, check whether the necessary connections can still be reached after mounting.
- Depending on the product and mounting method, you may not need all parts of the mounting kit. It is therefore possible that unneeded screws and other small parts will be left over even after correct mounting. Keep these in a safe place together with these operating instructions for use for later reference (sale of the product, moving house, relocation of the bracket, new TV, etc.).

Warning



- Be aware that the brackets are only suitable for wall mounting.
- Before installation, check that the wall you have chosen is suitable for the weight to be mounted. Also make sure that there are no electric, water, gas or other lines running through the wall at the mounting site.

Note - Fischer plugs



The Fischer plugs supplied are approved for the following building materials:

- Concrete
- Plasterboard and gypsum fibreboard
- Vertical perforated brick
- Lightweight concrete hollow block
- Hollow brick and concrete ceilings
- Perforated sand-lime brick
- Solid sand-lime brick
- Natural stone
- Aerated concrete
- Chipboard
- Solid plaster boards
- Lightweight concrete solid block
- Solid brick



6.1 Assembly preparation

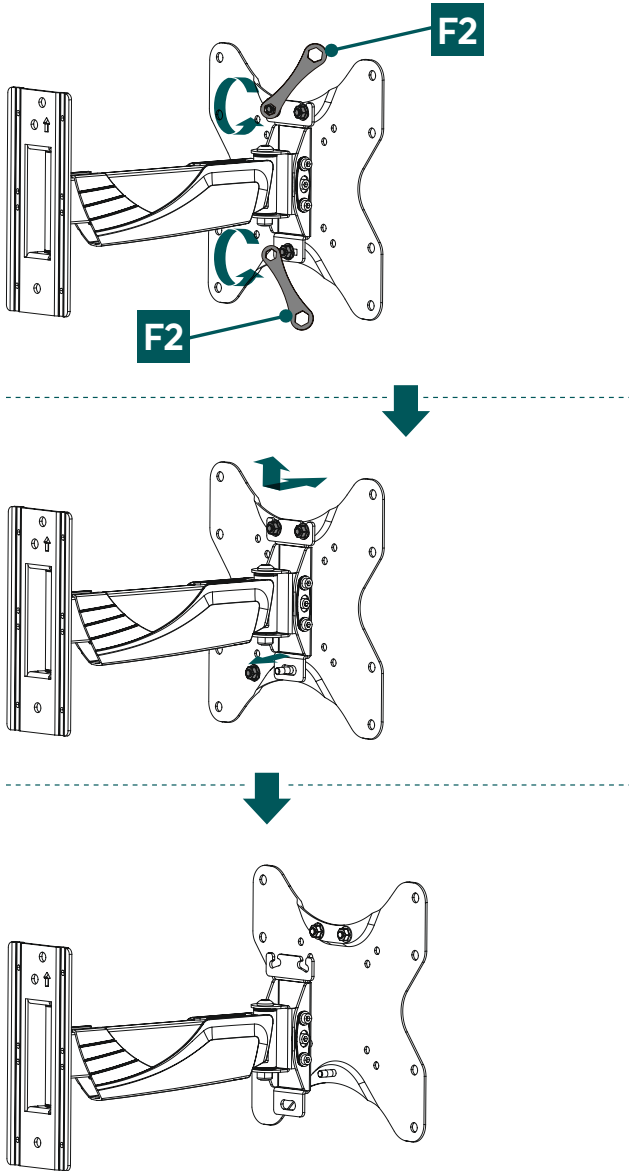

- First loosen the two upper flange nuts using the hexagon ring spanner [F2].
- In the next step, loosen the lower flange nut as shown above.
- Remove the VESA plate from the wall bracket by lifting it up.

6.2 Mounting on the wall

6.2.1 Preparing the intended mounting surface

Get support and help from other people for the following assembly steps.

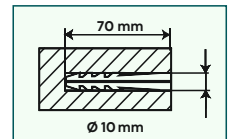
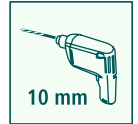
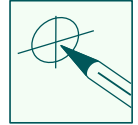
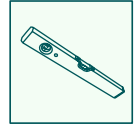
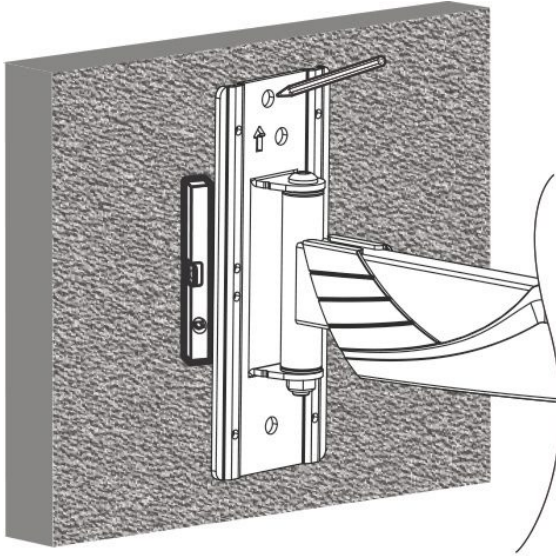

- First use the bracket as a template and re-measure if necessary to ensure that the position is correct. Use a spirit level to check the horizontal and vertical alignment of the bracket on the wall. Now mark the holes on the wall.
- To attach the wall bracket to the wall, you need a drill and a drilling attachment with a diameter of 10mm. Make sure that the drilling attachment is suitable for the intended wall. The depth of the hole should be 70 mm .
- To ensure a secure hold, vacuum out the drill holes with a vacuum nozzle so that the drill hole is free of drill dust. Now insert the plug [A2] into the drill hole so that it is flush with the hole.

6.2.2 Attaching the wall bracket

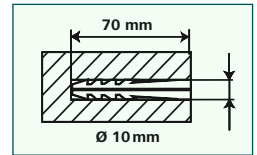
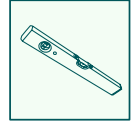
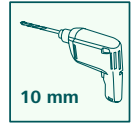
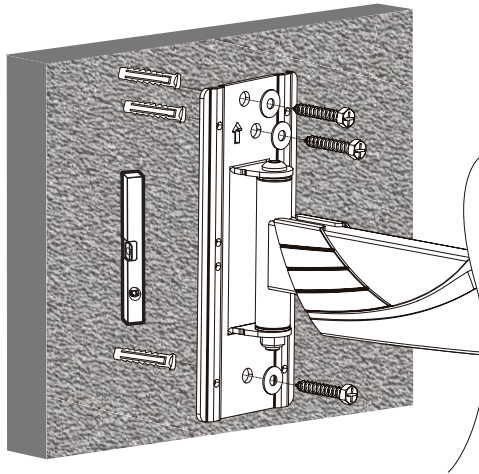

- Attach the wall bracket as shown above using the enclosed mounting material ([A2] plugs, [A3] M8 washer, [A1] 8x60 mm screw) to the wall.

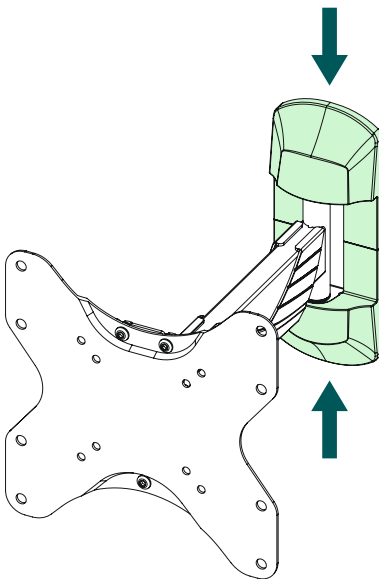

- Then attach the two enclosed covers to the bracket.



6.3 Mounting on the TV set

Note

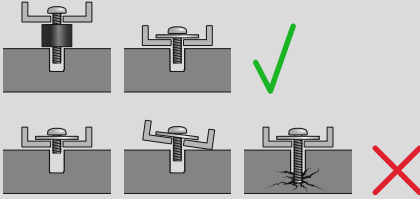

- Given the multitude of terminal devices structures available on the market, we cannot describe all possible mounting options here.
- Please ensure that the bracket lays flat and evenly on the back of the television.
- Use the enclosed spacer to even out any unevenness on the back of the television.
- Ensure that all screws have the proper length and can be mounted until they are hand-tight.

6.3.1 Mounting the VESA plate on the back of the TV set

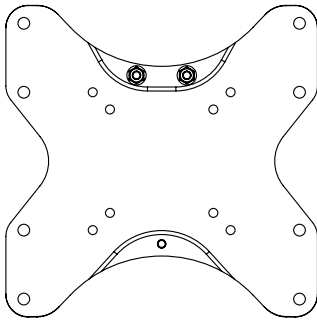

- Ensure that the VESA plate is correctly aligned. The upper side is the one that is fitted with two flange nuts

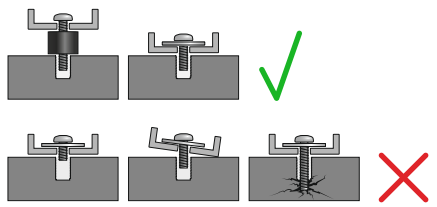
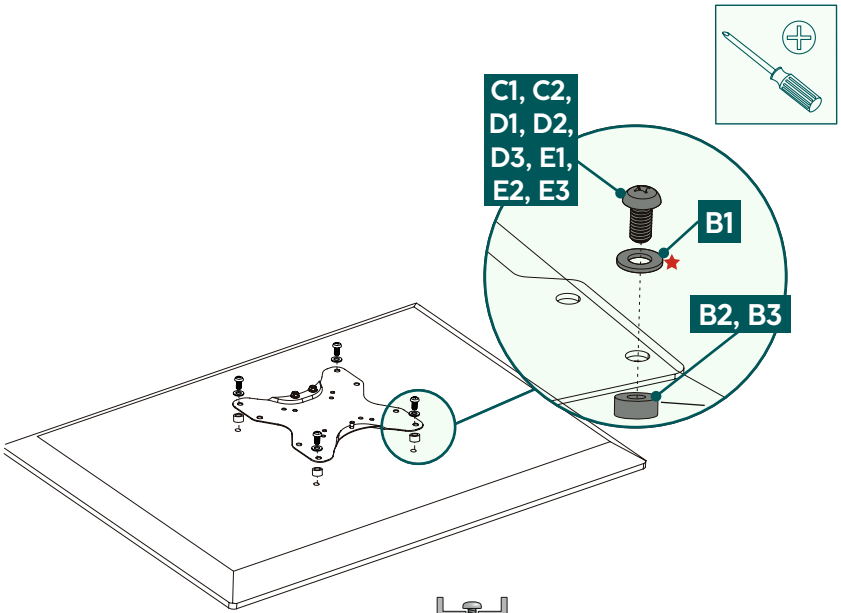

Flat TV back

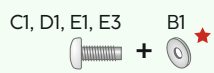

★ You do not need a washer for the D-screws

Curved TV back

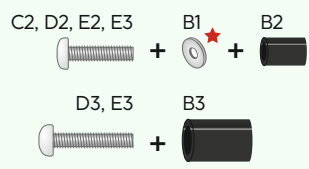

- Mount the VESA plate onto the back of your TV set.
- Note the combination of screw, washer and spacer listed above for your flat or curved TV.



6.4 Mounting the TV on the wall bracket

Get support and help from other people for the following assembly step.

During installation, the joints must be adjusted so that lateral movement of the TV set is possible.

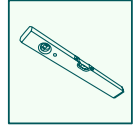
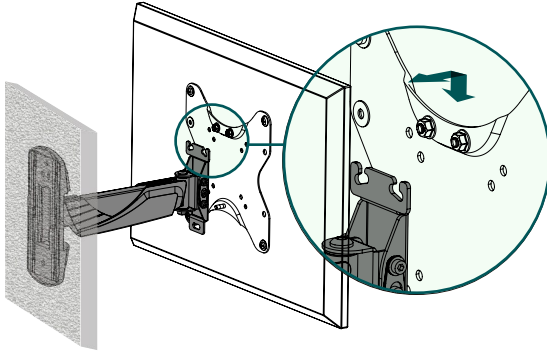

- Hang the TV with the mounted VESA plate on the wall bracket as shown above.

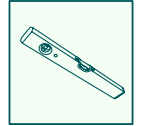
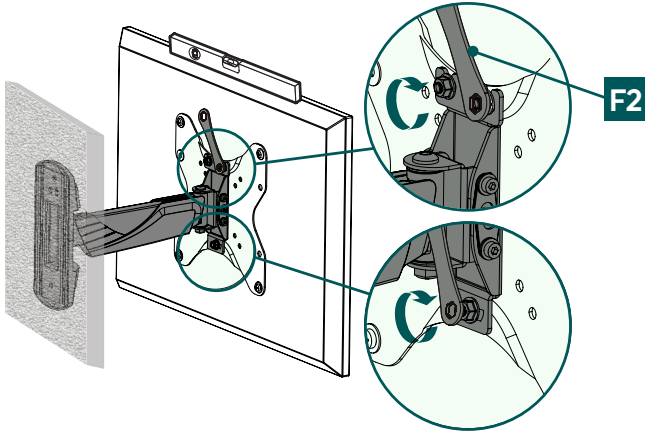

- Then tighten the fixing screws with the enclosed hexagon ring spanner [F2].



6.5 Mounting the cable manager

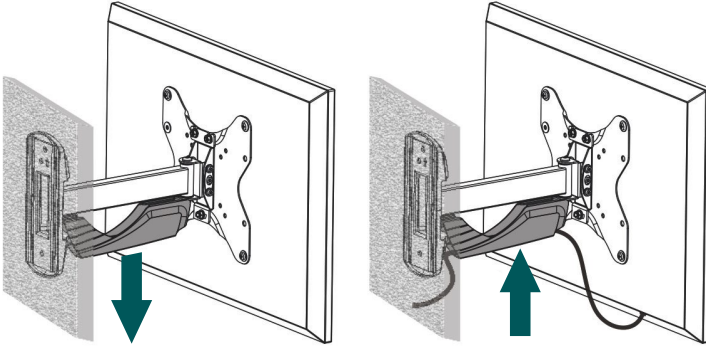

- First remove the pre-assembled cable manager from the wall bracket.
- Attach the cable manager to the arm of the bracket as shown above until you hear it click into place.

7. Adjustment & maintenance

Note

Never adjust the bracket alone. Seek assistance and help!



Note - tiltable / full-motion brackets

- Ensure that no electrical cables are crushed or damaged during installation or adjustment.
 - During adjustment, ensure that the product is loaded symmetrically and that the maximum permitted carrying capacity is not exceeded.
-
- Check the strength and operational safety of the bracket and the load attached to it at regular intervals (at least quarterly).
 - Clean only with water or conventional household cleaners.





8. Setting options

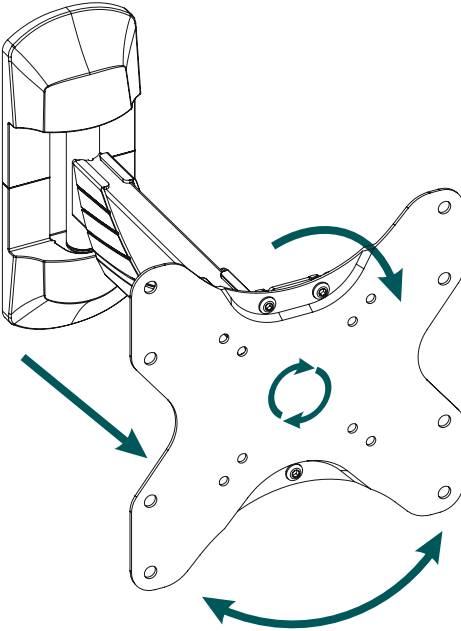

180°
Swivel



48 - 299 mm
extendable



-15°/+10°
Tilting



6°
Rotating

- No screws need to be loosened for the tilt adjustment and sideways movement.



9. Technical data

Maximum load:	35 kg
Screen diagonal:	48.0 - 122.0 cm (US: 19" - 48")
Depth:	4.8 cm - 29.9 cm
Tilt:	-15°/+10° (depending on device)
Swivel range:	Up to 180° (depending on device) at 2 joints
Dimensions of the wall mounting plate:	8.6 x 22.0 cm
Mount:	Compliant with VESA standard: 75 x 75 100 x 100 200 x 100 200 x 200



10. Warranty disclaimer

Hama GmbH & Co KG assumes no liability and provides no warranty for damage resulting from improper installation/mounting, improper use of the product or from failure to observe the operating instructions and/or safety notes.

11. Service and support

Please contact Hama Product Consulting if you have any questions about this product.

Hotline: +49 9091 502-0 (German/English)

Further support information can be found here: www.hama.com

12. Warranty conditions

For this product, HAMA GmbH & Co KG grants you an extended manufacturer's warranty for freedom from defects, usability, workmanship and the durability of the materials used for a period of 10 years. Excluded from the guarantee is the compatibility of the product with future standards of further developed hardware.

Within the specified period, Hama GmbH & Co KG will remedy a justified warranty claim at its own discretion, free of charge, either by repair or replacement.

The warranty period begins on the date of purchase of this product and is valid throughout the EU.

The warranty granted is in addition to and does not affect your statutory rights. Damage caused by improper use, normal wear and tear, exposure to chemicals or force majeure, as well as tampering or repairs by you or third parties, are excluded from the warranty.

Furthermore, accessories that are not part of the basic equipment of the product (promotional parts) are excluded from the warranty.

In the event of a warranty claim, please contact us at Hama GmbH & Co KG, Dresdner Str. 9, 86653 Monheim, Germany, enclosing proof of purchase. You are also welcome to contact us at www.hama.de or by phone on +49 (0)9091/502-0.