

5 Mounting the VESA plate

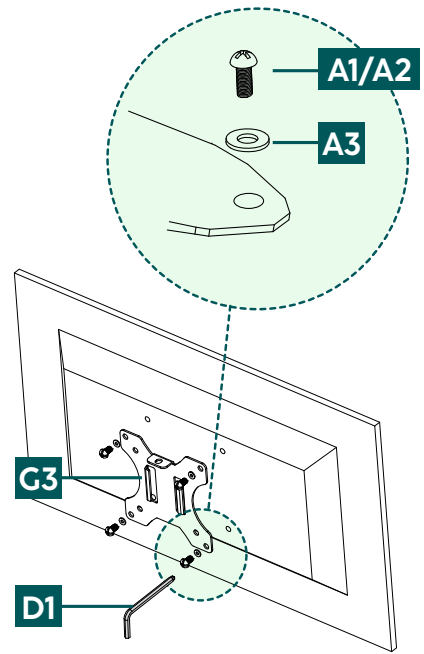

6 Mounting the monitors

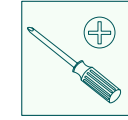
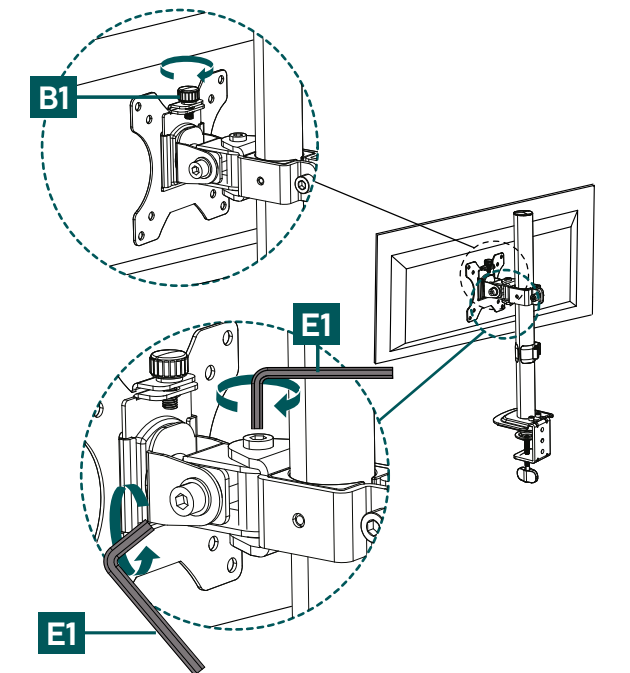

7 Thread the cable

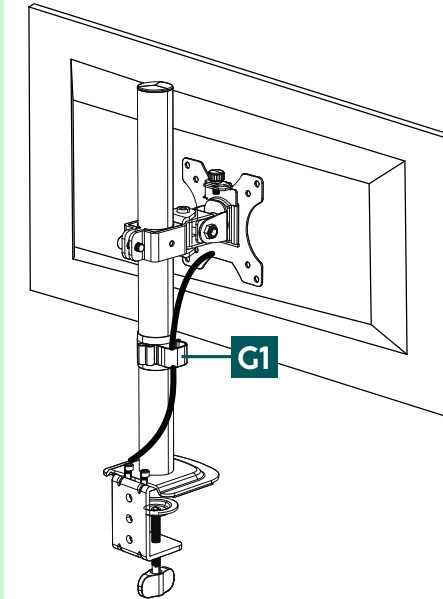

Do you need more help?

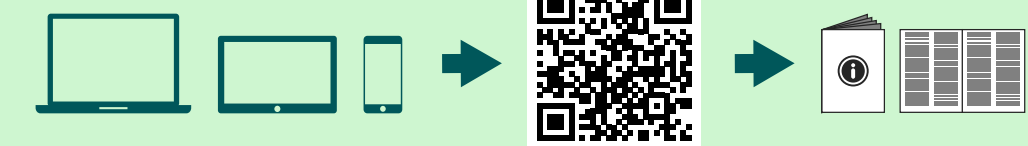

Scan QR or visit: [support.hama.com/00220900](http://support.hama.com/00220900)

We are so happy you have chosen a Hama product.

**Enjoy using it!**



**hama**







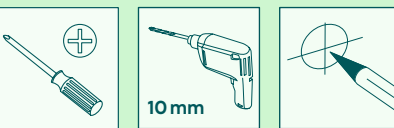



# Quick Installation Guide

## Required tools

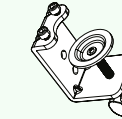
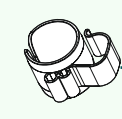
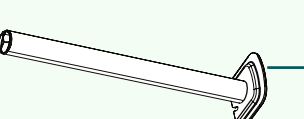
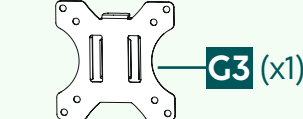
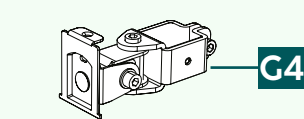

## Installation kit

<b>A1</b>  M4x12 (x4)	<b>A3</b>  D5 (x4)	<b>C1</b>  (x3)	<b>E1</b>  6 mm (x1)
<b>A2</b>  M5x12 (x4)	<b>B1</b>  (x1)	<b>D1</b>  5 mm (x1)	<b>H1</b>  (x2)
<b>F1</b>  (x1)	<b>G1</b>  (x1)	<b>G2</b>  (x1)	<b>G3</b>  (x1)
			<b>G4</b>  (x1)



**1** Preparing Attach foam strips

**2a** Option A: Clamp mounting - Assembling

**2b** Option A: Clamp mounting - Attach to the table

**3a** Option B: Drilling - Prepare for assembling

**3b** Option B: Drilling - Assembling

**4** Mounting the monitor arm