

We are so happy you chose a
hama product.

Enjoy using it!



hama

Quick Installation Guide

Required tools

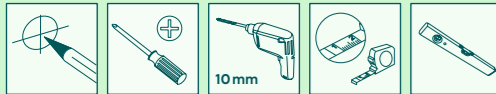

Installation kit

A1		8x70 (x4)	C2		M6x20 (x4)
A2		Ø10x60 (x4)	D1		M8x12 (x4)
A3		M8 (x4)	D2		M8x20 (x4)
B1		M6 (x4)	D3		M8x30 (x4)
B2		Ø8x10 (x4)	D4		M8x50 (x4)
B3		Ø8x20 (x4)	F1		(x1)
C1		M6x12 (x4)	F2		(x1)

Do you need more help?



Scan QR or visit:
support.hama.com/00220898



1 Drilling the holes

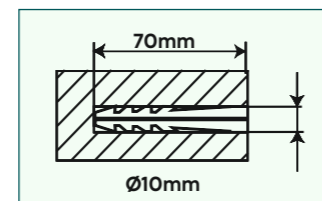
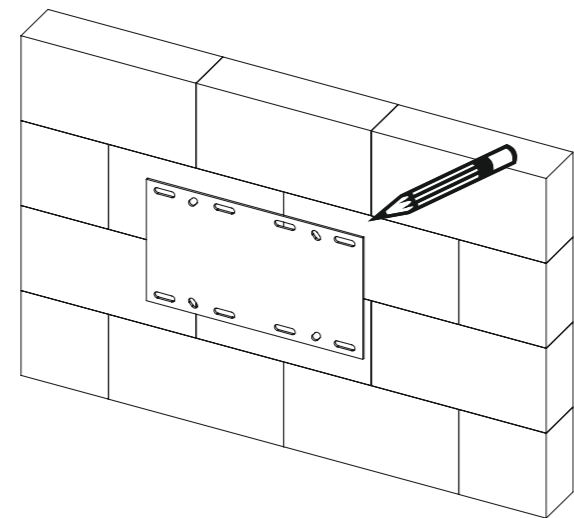
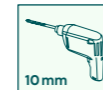

2 Wall mounting the bracket

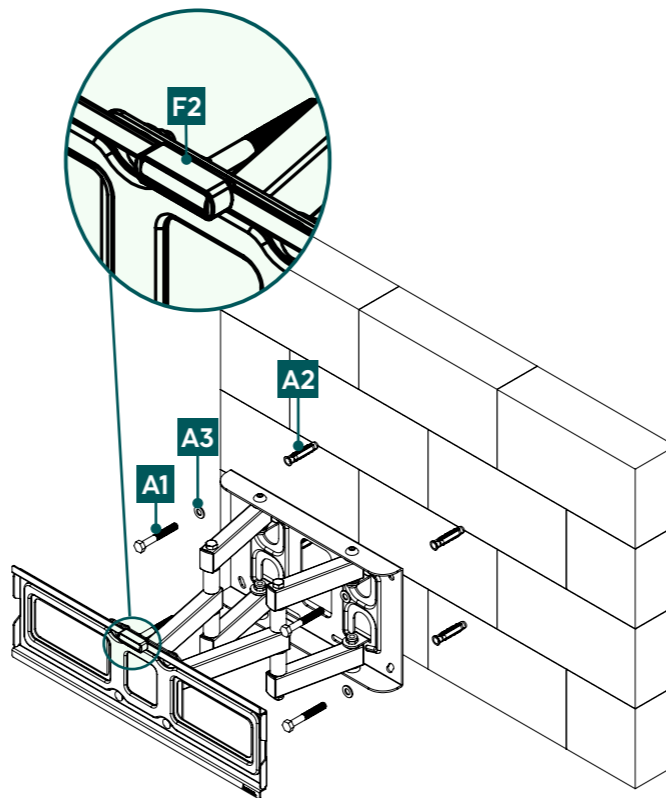

3 Mounting on backside of the TV

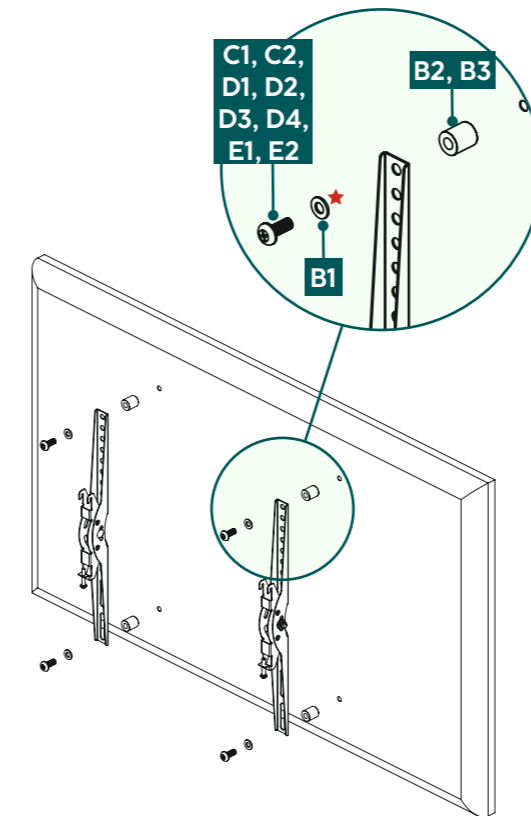

Flat TV backside

C1, D1, D4, E1 + B1

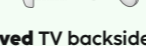

Curved TV backside

C2, D2, D4, E2 + B1 + B2



D3, D4 + B3

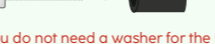

★ You do not need a washer for the D-screws

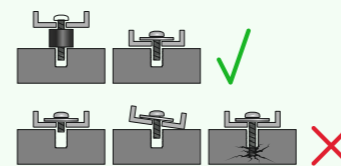
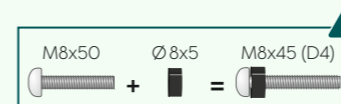

4 Fixing the wall bracket

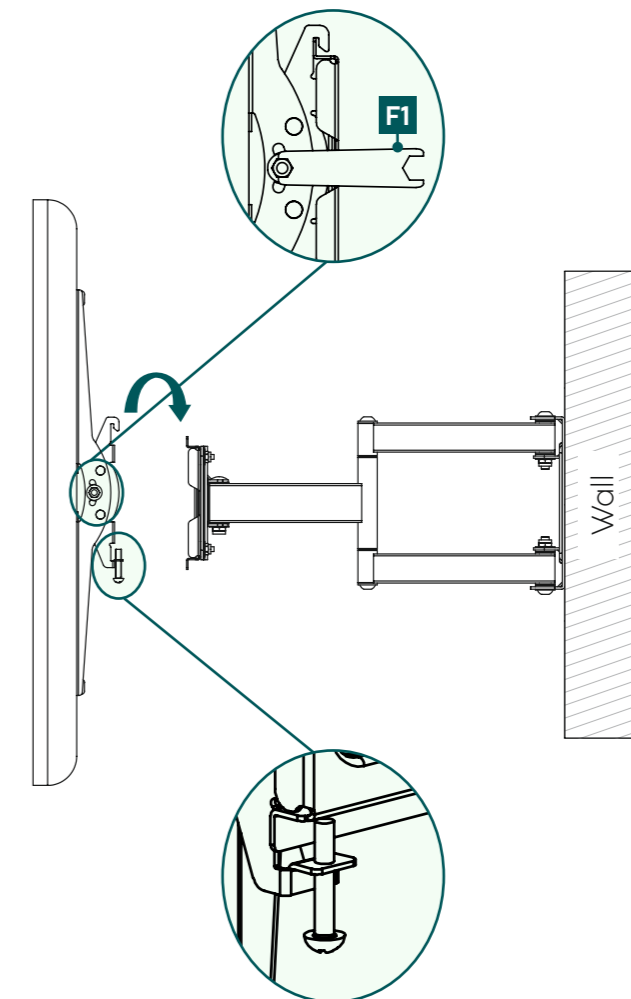

5 Adjustments

