

7 Mounting the backside of the TV

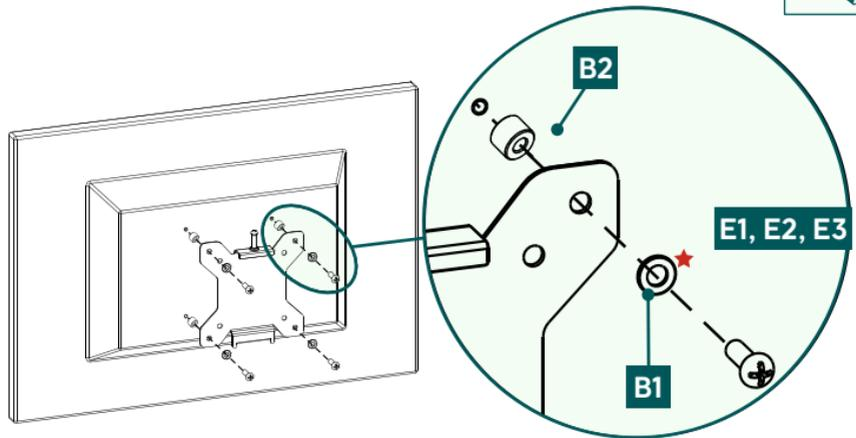

Flat TV backside

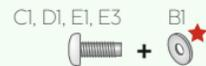

Curved TV backside

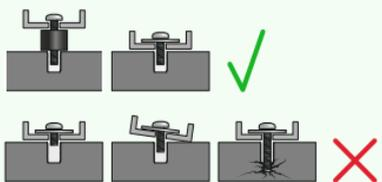
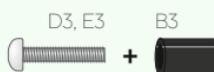
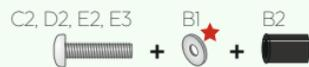

★ You do not need a washer for the D-screws

8 Mounting the TV on the bracket

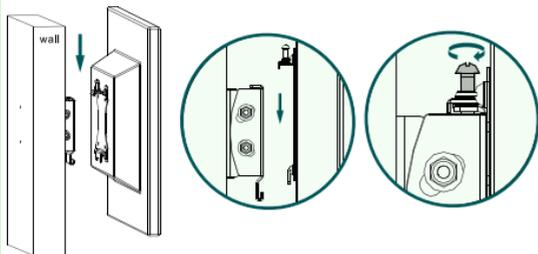

9 Adjustment & Fixing

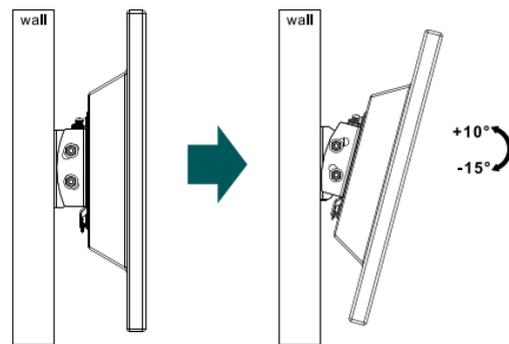

Do you need more help?

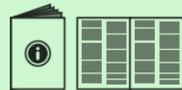

Scan QR or visit:
www.hama.com
→ 00220802
→ Downloads



PAP
Raccolta Carta



hama

We are so happy you chose a hama product.

Enjoy using it!

Quick Installation Guide

Required tools

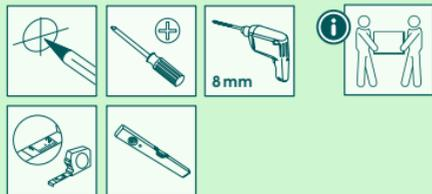

Installation kit

A1		5,5x50 (x2)
A2		Ø8x50 (x2)
A3		M6 (x2)
B1		M6 (x4)
B2		Ø8x10 (x4)
E1		M4x12 (x4)
E2		M4x20 (x4)
E3		M4x45 (x4)

1 Mark the holes

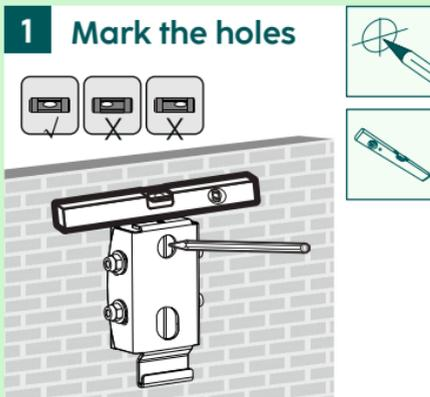

2 Drilling the holes

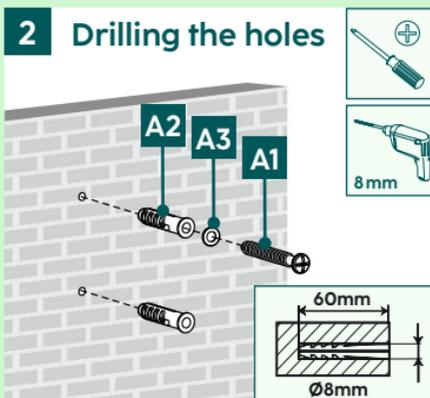

3 Wall mounting the bracket

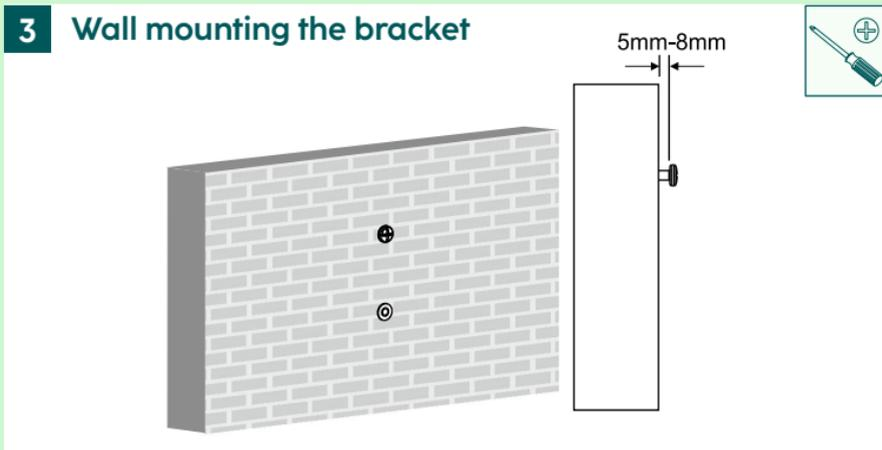

4 Wall mounting the bracket

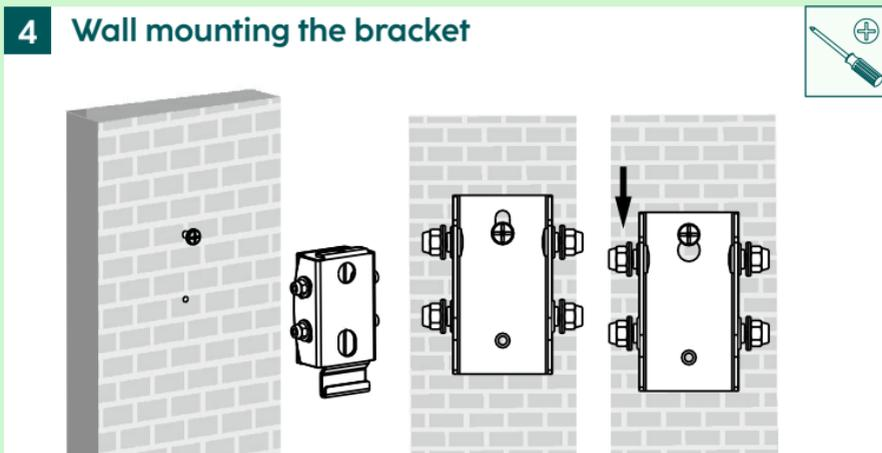

5 Wall mounting the bracket

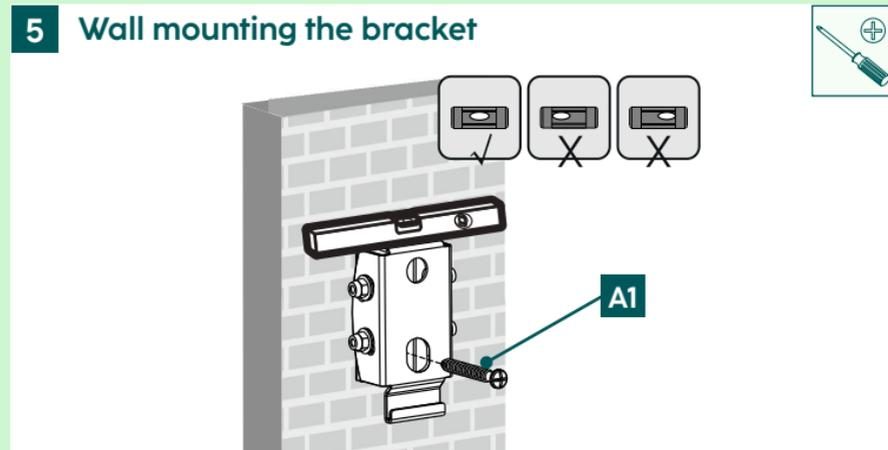

6 Mounting on backside of the TV

