

hama

00176652

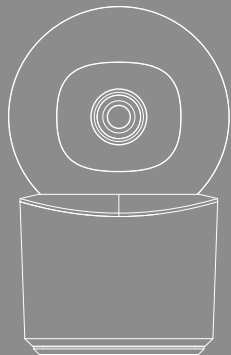

SMART CAMERA



Read the warnings and safety instructions on the enclosed note before using the product.

Lesen Sie vor der Nutzung des Produktes die Warn- und Sicherheitshinweise auf dem beiliegenden Hinweiszettel.

F Veuillez lire les avertissements et consignes de sécurité de la fiche ci-jointe avant d'utiliser le produit. **E** Antes de utilizar el producto, lea las advertencias e instrucciones de seguridad en la hoja de información adjunta. **NL** Lees voordat u van het product gebruikmaakt, de waarschuwingen en veiligheidsinstructies op het bijgevoegde informatieblad. **IT** Prima dell'uso leggere attentamente le indicazioni di avvertimento e di sicurezza riguardanti il prodotto riportate sul foglio illustrativo.

PL Przed użyciem produktu należy zapoznać się z treścią wskazówek ostrzeżeń i wskazówek bezpieczeństwa znajdujących się na dołączonej ulotce informacyjnej.

H A termék használatá előt olvassa el a mellékelt tájékoztatólapon található biztonsági előírásokat és figyelmeztetéseket. **RO** Înainte utilizării produsului citiți avertizările și instrucțiunile de siguranță de pe fișa cu informații anexată.

CZ Před použitím si přečtěte výstražné a bezpečnostní pokyny uvedené na letáku přiloženém k produktu. **SK** Pred použitím výrobku si prečítajte výstražné a bezpečnostné upozornenia na priloženom listku s upozomením. **P** Antes da utilização do produto, leia os avisos e as indicações de segurança no folheto de instruções fornecido. **S** Läs varnings- och säkerhetsanvisningarna på medföljande informationsblad innan produkten används. **RUS** Перед использованием изделия ознакомьтесь с приложенными в комплекте правилами техники безопасности.

BG Преди да използвате продукта, прочетете предупредителните указания и инструкциите за безопасност в приложенния информационен лист. **GR** Πριν από τη χρήση του προϊόντος διαβάστε τις υποδείξεις ασφαλείας και προειδοποιήσεις στο παρεχόμενο σημείωμα οδηγιών. **TR** Ürünü kullanmadan önce ekteki bilgi notunda bulunan uyarı ve güvenlik bilgilerini okuyun. **FIN** Tue ennen tuotteen käyttöä oheisessa ohjelehtisessä olevat varoitukset ja turvaohjeet.



www.hama.com

00176652

→ Downloads



<https://www.hama.com/00176652>

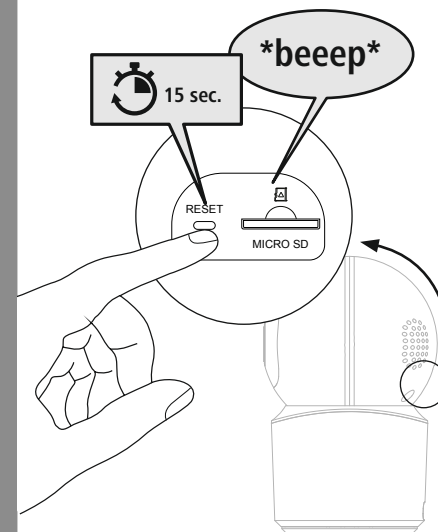
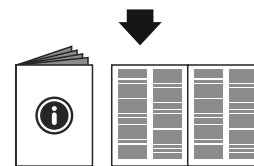

hama

Hama GmbH & Co KG
86652 Monheim / Germany

Service & Support

www.hama.com

+49 9091 502-0

D GB

All listed brands are trademarks of the corresponding companies. Errors and omissions excepted, and subject to technical changes. Our general terms of delivery and payment are applied.

00176652/05.24

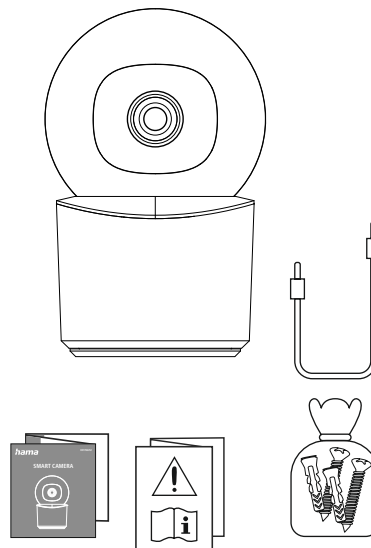



1



<https://link.hama.com/app/smart-home>



2

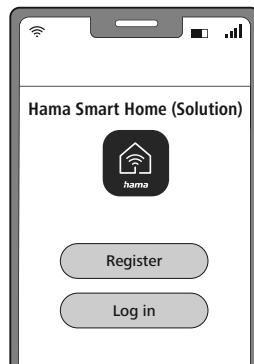
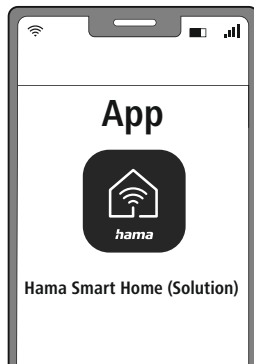

3

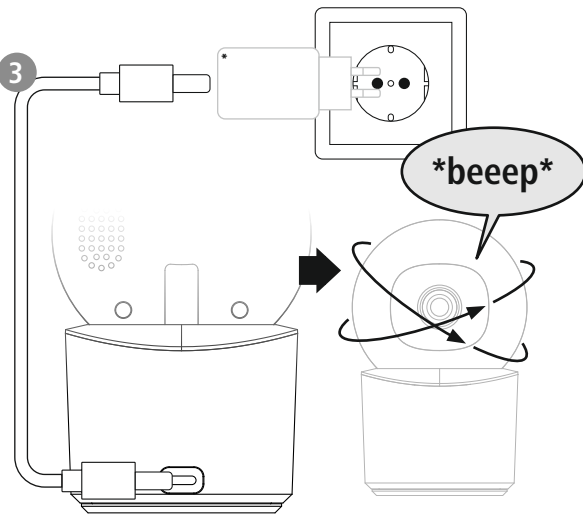

*not included

4

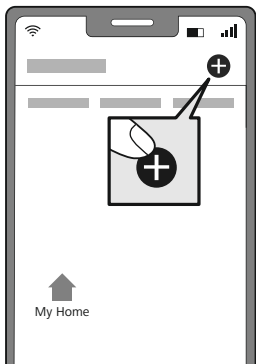

5

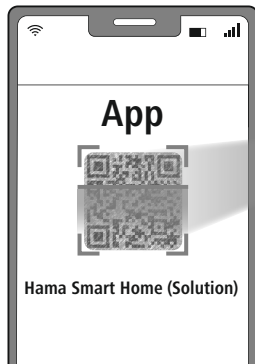

scan QR code with Product Camera

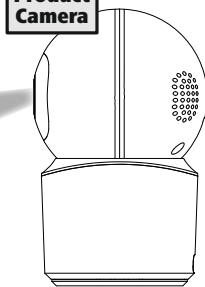

beep

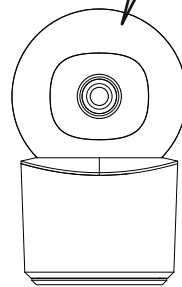

6

