

The transmission and reproduction of this document, utilization and communication of its contents are strictly prohibited unless expressly authorized. Offenders will be liable to pay damages. All rights in the event of patent, utility model or design patent registration reserved.

Weitergabe sowie Vervielfältigung dieses Dokuments, Verwertung und Mitteilung seines Inhalts sind verboten, soweit nicht ausdrücklich gestattet. Zuwiderhandlungen verpflichten zu Schadenersatz. Alle Rechte für den Fall der Patent-, Gebrauchsmuster- oder Geschmacksmustereintragung vorbehalten.

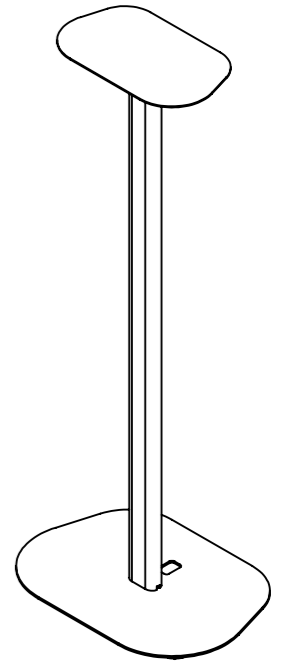
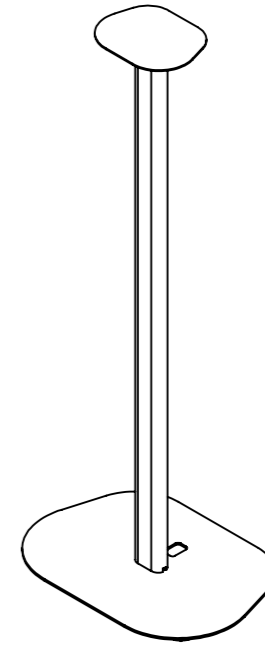
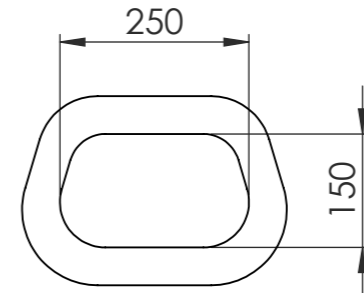
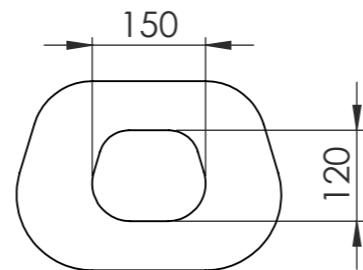
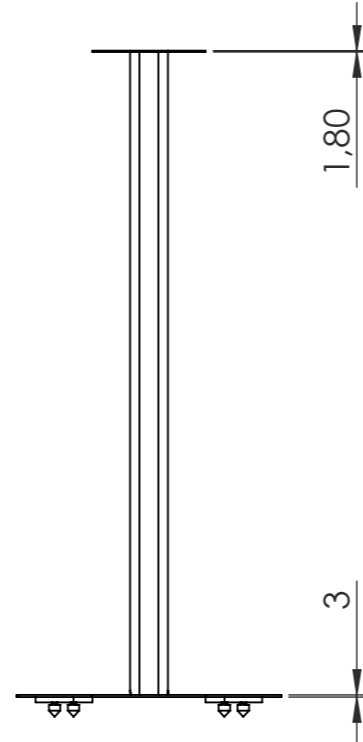
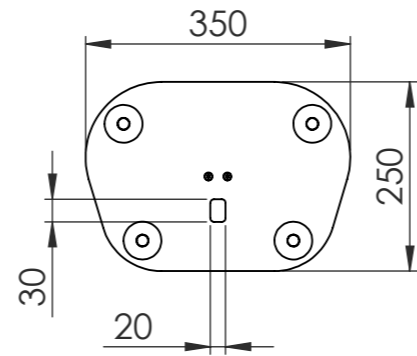
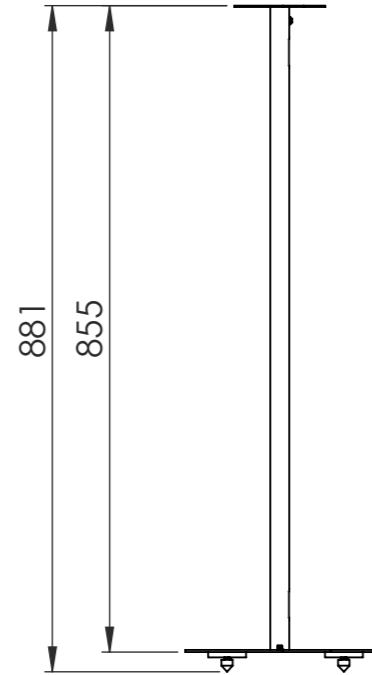
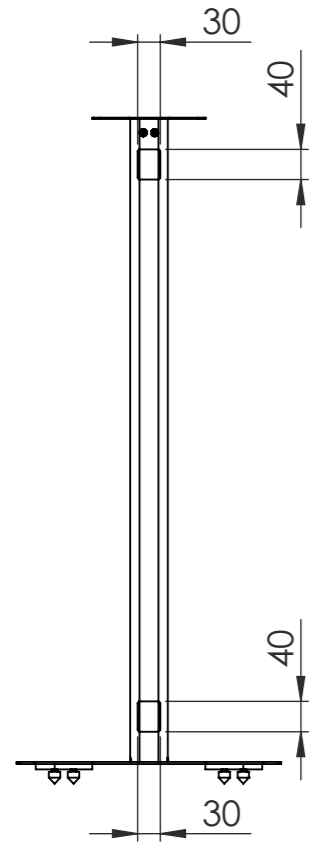

**Eigentumsrechte**

Die in dieser Zeichnung enthaltenen Informationen sind alleiniges Eigentum der Hama GmbH & Co. KG. Der Nachbau einzelner Teile oder im Ganzen sind ohne schriftliche Genehmigung der Hama GmbH & Co. KG verboten.

The information contained in this drawing is the sole property of Hama Company. Any reproduction in part or as a whole without the written permission of Hama Company is prohibited.

Alle Maße in mm / all dimensions in mm

<b>hama</b> <sup>®</sup>		Allgemein-toleranzen DIN ISO 2768-mK		 DIN 6 T1 - Proj.methode 1		Rohabmessung:	
		Datum		Name		Material: Lagerplatz:	
Erstellt		05.07.2016		K.Kimmerle		Gewicht (kg):	
Gepr.						Benennung / Description:	
Freig.						<b>Lautsprecherständer / speaker stand</b>	
				Hama GmbH & Co KG		Artikelnummer / Part Number:	
				86653 Monheim/Germany		Status In Arbeit	
				www.hama.com		Format A3	
Rev		Änderung		Datum		Name	
						Schutzvermerk ISO 16016 beachten	
						Identnummer: 0000042140	
						Maßstab / Scale 1:10	
						Blatt / von 1 / 1	