

00054874
(DR1550CBT)

hama

Digital Radio

Digital-Radio

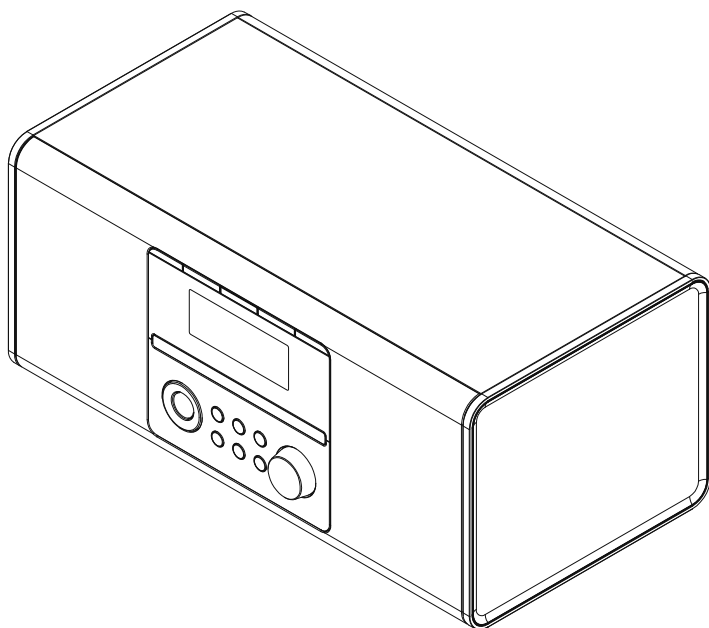

Operating Instructions / Bedienungsanleitung / Mode d'emploi / Instrucciones de uso /
Руководство по эксплуатации / Istruzioni per l'uso / Gebruiksaanwijzing / Οδηγίες χρήσης / Instrukcja obsługi /
Használati útmutató / Návod k použití / Návod na použitie / Manual de instruções / Kullanma kılavuzu /
Manual de utilizare / Bruksanvisning / Käyttöohje / Работна инструкция / Betjeningsvejledning / Manuelt stasjonssøk





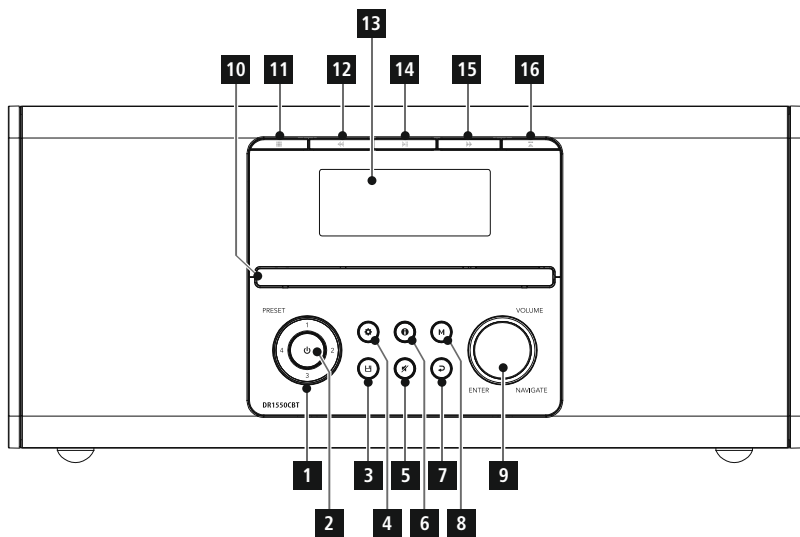
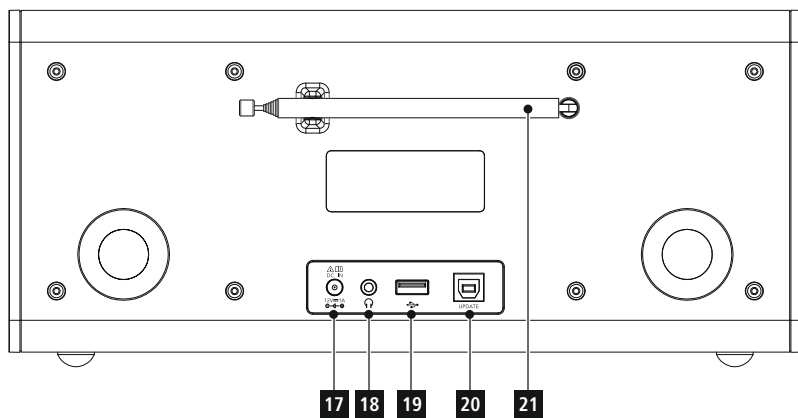

Technical data

Digitalradio	DAB ✓	DAB+ ✓	FM ✓	Internet -	Spotify -
CD drive	✓				
Display	3.0" (7.62 cm) Liquid Crystal Display (LCD)				
Connectivity	USB (Playback), Bluetooth V2.1 + EDR				
Bluetooth® profile	A2DPv1.2, AVRCPv1.0				
Power input	12 V= 1.0 A				
Power Consumption	Operation/ Betrieb	max. 12 W	Standby	< 1 W	
Frequency range	DAB/DAB+ 174 – 240 MHz		FM 87.5 – 108 MHz		
Input & Output	DC Socket, Headphone 3.5 mm, Update Port, USB				
Presets	DAB/DAB+: 30	FM: 30			
UI Languages	English, German, Dutch, French, Italian				
Package Content	Digital Radio "DR1550CBT", Power Supply, Short Manual				
Dimensionen (WxHxD)	33 x 15 x 15 cm				
Weight	2.3 kg				



A**B**

Controls and Displays

A: Front		
1		Presets 1-4
2		[POWER] button
3		[MEMORY] button
4		[MENU/SETTINGS] button
5		[MUTE] button
6		[INFO] button
7		[BACK] button
8	M	[MODE] button
9		[NAVIGATE/ENTER/ VOLUME] button
10		CD drawer
11		Stop
12		Back / Rewind
13		Display
14		Play/Pause
15		Next / FF
16		Eject/Insert

B: Reverse		
17	<i>DC IN</i>	Mains power supply
18		Headphone socket
19		USB interface
20		Update port
21		Telescopic aerial

1. Explanation of Warning Symbols and Notes	5
2. Package Contents	5
3. Safety Notes	5
4. Informations and notes before getting started	5
5. Getting started	5
5.1 Radio – Connecting and starting up	5
5.2 General notes on use	6
6. Main menu / modes	6
7. Digital radio (DAB/DAB+)	6
7.1 Search / Automatic search	6
7.2 Station list	7
7.3 Edit station list	7
7.4 Presets	7
7.4.1 Assigning the Presets shortcut buttons	7
7.4.2 Calling up shortcut button presets	7
7.4.3 Assigning the list of presets (1-30)	7
7.4.4 Calling up a station from the Presets list (1-30)	7
7.5 DRC (Dynamic Range Control)	8
7.6 Station sequence	8
8. FM	8
8.1 Scan setting	8
8.2 Search / Automatic search	8
8.3 Presets	8
8.3.1 Assigning the Presets shortcut buttons	8
8.3.2 Calling up shortcut button presets	8
8.3.3 Assigning the list of presets (1-30)	9
8.3.4 Calling up a station from the Presets list (1-30)	9
8.4 Audio setting	9
9. CD player	9
9.1 Insert/Eject disc	9
9.2 Additional functions	9
10. Playback from external storage media (USB)	10
11. Bluetooth	10
11.1 Bluetooth® pairing	10
11.2 Automatic Bluetooth® connection (after successful pairing)	10
11.3 Terminating the Bluetooth® connection	11
12. Sleep	11
13. Alarms	11
13.1 Alarm settings	11
13.2 Activating / deactivating the alarm	11
13.3 Stopping the alarm/ Snooze function	11
14. System settings	11
14.1 Time/ Date settings	12
14.2 Language	12
14.3 Factory Reset	12
14.4 Software update	12
14.5 Info	12
14.6 Lighting	13
15. Care and Maintenance	13
16. Warranty Disclaimer	13
17. Recycling Information	13
18. Declaration of Conformity	13



Menu structure

Main Menu

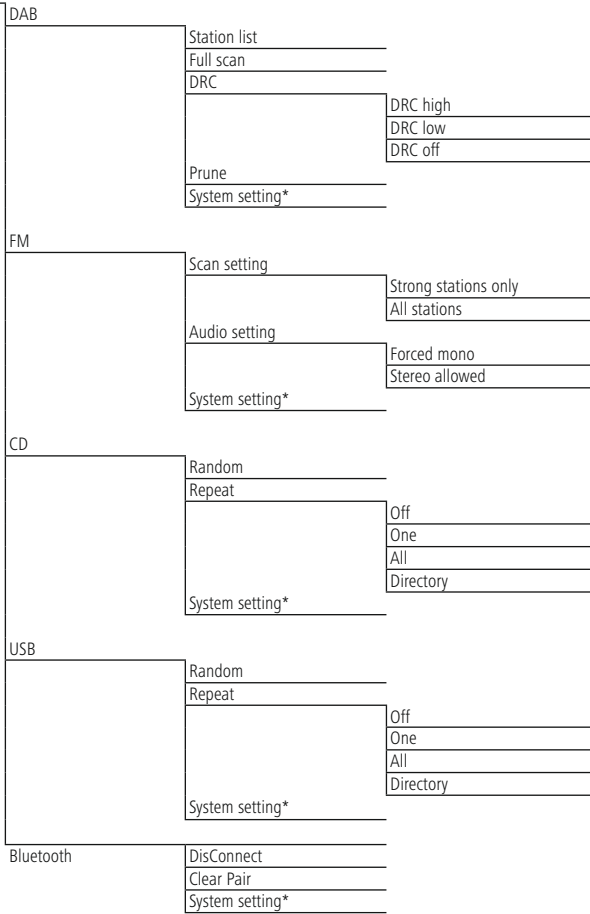

System setting*

Sleep Timer		
Set alarm		
	Alarm 1	
	Alarm 2	
Snooze adjust		
Set Time		
	Date/Time Set	
	Auto update	DAB
		FM
		from Any
		No update
	Time mode	
	Date format	
Brightness		
	Dim level	Low
		High
		Medium
	Standby	Low
		High
		Medium
Language		
Factory Reset		
Software Upgrade		
SW version		



Thank you for choosing a Hama product. Take your time and read the following instructions and information completely. Please keep these instructions in a safe place for future reference. If you sell the device, please pass these operating instructions on to the new owner.

1. Explanation of Warning Symbols and Notes

Warning



This symbol is used to indicate safety instructions or to draw your attention to specific hazards and risks.

Note



This symbol is used to indicate additional information or important notes.

Risk of electric shock



This symbol indicates product parts energized with a dangerous voltage of sufficient magnitude to constitute a risk of electric shock.

2. Package Contents

- DR1550CBT digital radio
- AC/DC adapter
- Quick guide

3. Safety Notes

- The product is intended for private, non-commercial use only.
- Do not use the product in the immediate vicinity of heating, other sources of heat or in direct sunlight.
- Protect the product from dirt, moisture and overheating and use it in dry rooms only.
- As with all electrical devices, this device should be kept out of the reach of children.
- Children must not play with the device. Cleaning and user maintenance must not be carried out by children without supervision.
- Do not use the product in areas in which electronic products are not permitted.
- Be considerate. High volumes can disturb or interfere with your surroundings.
- Do not drop the product and do not expose it to any major shocks.
- Do not operate the product outside the power limits given in the technical data.
- Keep the packaging material out of the reach of children due to the risk of suffocation.
- Dispose of packaging material immediately according to locally applicable regulations.
- Do not modify the device in any way. Doing so voids the warranty.

Risk of electric shock



- Do not open the device or continue to operate it if it becomes damaged.
- Do not use the product if the AC adapter, adapter cable or power cable is damaged.
- Do not attempt to service or repair the product yourself. Leave any and all service work to qualified experts.

4. Informations and notes before getting started

Note



- For best reception, ensure that the antenna is fully extended and vertical.
- Try various different positions if necessary to get the best reception.

5. Getting started

5.1 Radio – Connecting and starting up

Connect the power supply to the mains connection (1) on the back of the radio.

Connect the network cable to a properly installed and easily accessible network socket. The power supply unit is suitable for mains voltages between 100 and 240 V, and is thus operable on almost any AC power grid. Please note that a country-specific adapter may be necessary. You can find an appropriate selection of Hama products at www.hama.com.

Note



- Only connect the product to a socket that has been approved for the device.
- When using a multi-socket power strip, make sure that the sum power draw of all the connected devices does not exceed its maximum throughput rating.
- The electrical socket must always be easily accessible.
- If you will not be using the product for a long period of time, disconnect it from mains power.

Once the product has been connected to mains power, initialisation takes place. The radio starts up.



5.2 General notes on use

Note



- When a selection among menu items is to be made (such as **YES** or **NO**), the one currently selected has a light-coloured background fill.
- In menus offering a variety of different options (such as Language, Update, and so on), the currently selected option is marked with an asterisk (*).

Navigation and controls

- Select among menu items by turning **[NAVIGATE/ENTER/VOLUME]**.
- Confirm the selection by pressing **[NAVIGATE/ENTER/VOLUME]**.
- After pressing a shortcut button, navigate amongst the menu items using **[NAVIGATE/ENTER/VOLUME]**.

Volume adjustment / mute

- You can turn the volume up (right) or down (left) by turning **[NAVIGATE/ENTER/VOLUME]** (9) accordingly.
- Press **[M]** (5) to mute the radio.
- Press **[M]** (5) again to reset the volume to the value it was prior to the radio being muted.

Entering passwords, search terms, and so on.

- Select each successive letter and digit by turning **[NAVIGATE/ENTER/VOLUME]** and confirm each selection by pressing **[NAVIGATE/ENTER/VOLUME]**.
- To make corrections, select **[BKSP / <-]** and confirm. The last input made is deleted.
- To cancel input, select **[CANCEL]** and confirm.
- Once your input is complete, select **[OK]** and confirm to finish.

Additional information

Depending on the operating mode and stations available, pressing **[i]** (6) displays additional information:

• Description

Indicates the radio station, the current program, contents, subjects, etc.

• Genre

The genre (music style) of the station is shown.

• Bit rate

The currently received digital bit rate of the received station is displayed.

• Channel information

• Current time

• Today's date

Switch On/Off / Standby

- Press **[P]** (2), to switch the device on or off (Standby).
- To completely switch off the device, disconnect it from the power supply.

6. Main menu / modes

This device supports radio reception via the Internet, DAB/ DAB+ and FM.

The main menu contains the various operating modes as well as other options that are explained separately in the following chapters:

7. DAB

8. FM

9. CD player

10. Playback from external storage media (USB)

11. Bluetooth

12. Sleep

13. Alarm

14. System settings

Select amongst the available operating modes by repeatedly pressing **[M]** (8).

During playback, the current operating mode appears at the top left-hand edge of the screen.

7. Digital radio (DAB/DAB+)

The radio receives all established digital radio frequencies in the range of 174 MHz to 240 MHz (band III, channel 5A to 13F).

From the main menu or after pressing **[M]** repeatedly, activate operating mode **DAB (DAB Radio)** on the radio.

7.1 Search / Automatic search

The automatic DAB channel search scans the DAB band III for available stations. After the station search, all interference-free stations are saved in alphabetical order. In Stations list a ? is displayed in front of the station names of stations found during a previous scan but which cannot currently be received.

The automatic DAB station search starts automatically when DAB mode is started for the first time; it is indicated by **Scanning...** and a status bar on the display.



If you would like to start the search again, proceed as follows:

- Press **[⚙️]** (4) to access the Settings menu.
- Use **[NAVIGATE/ENTER/VOLUME]** (9) to navigate to the "Scan" menu item.
- Confirm the selection by pressing **[NAVIGATE/ENTER/VOLUME]**.
- Wait until the search process has completed.
- The available stations are now displayed in the list of stations.

7.2 Station list

You can call up the station list in DAB mode at any time. To do so, proceed as follows:

- Press **[↔️]** (7) during playback to navigate through the available stations in ascending alphabetical order using **[NAVIGATE/ENTER/VOLUME]**.
- Confirm the selection by pressing **[NAVIGATE/ENTER/VOLUME]**.
- The device starts playback automatically.

Note

The list of stations contains all stations that were found on the last station search. A further station search - as described in **7.1 Search / Automatic search** - can be started. A station's reception quality depends on factors such as the weather, location and orientation of the aerial. If a station shown in the list of stations is not available, changing the orientation of the aerial or the location of the radio may help. Stations that are not available can be removed from the list of stations as described in **7.3 Edit station list**.

7.3 Edit station list

To remove stations that are not currently in the reception area, from your station list, proceed as follows:

- Press **[⚙️]** (4) to access the Settings menu.
- Use **[NAVIGATE/ENTER/VOLUME]** (9) to navigate to the "Prune invalid" menu item.
- Confirm the selection by pressing **[NAVIGATE/ENTER/VOLUME]**.

If you answer **YES**, then all currently unavailable stations will be removed from the station list.

Note

To keep the list of stations up to date, we recommend updating the list regularly with a full station search (see **7.1 Search / Automatic search**).

7.4 Presets

You can save up to 30 of your favourite stations for quick and direct access.

7.4.1 Assigning the Presets shortcut buttons

- Set the station that you would like to save as a favourite station preset.
- Once the station is playing, press and hold the relevant shortcut button for around 3 seconds.
- The selection will be confirmed by the display showing "Preset (1-4, depending on shortcut key) stored".
- During playback, the Preset memory slot is displayed at the right-hand edge of the screen.

Note

Favourites cannot be deleted. If all 30 station memory slots are filled and you wish to save a new station, choose one of the occupied slots. The station in this slot will be overwritten with the new station.

7.4.2 Calling up shortcut button presets

To call up a preset station, press the corresponding shortcut button **(2-5)**.

7.4.3 Assigning the list of presets (1-30)

- Set the station that you would like to save as a favourite station preset.
- If the station is playing, press and hold **[H]** (3) for approx. 3 seconds until the Presets list opens up.
- Navigate to the preferred memory slot and confirm your selection by pressing **[NAVIGATE/ENTER/VOLUME]**.
- The selection will be confirmed by the display showing "Preset (1-30, depending on storage space) stored".

7.4.4 Calling up a station from the Presets list (1-30)

- Press **[H]** to call up the Presets list.
- Use **[NAVIGATE/ENTER/VOLUME]** to navigate to the preferred station and confirm your selection by pressing **[NAVIGATE/ENTER/VOLUME]**.



7.5 DRC (Dynamic Range Control)

Some DAB network radio stations support a volume control feature that actively takes effect during playback. If the volume suddenly increases, DRC automatically lowers it. If the volume suddenly becomes quieter, DRC automatically raises it. The same happens when playback is suddenly quiet. The radio then increases the volume again.

DRC high: total equalisation of different volumes. Strong compression can audibly reduce the dynamics of a music title.

DRC low: partial equalisation of different volumes. More subtle compression, without too much loss of dynamics.

DRC off: no equalisation

Proceed as follows to do the settings:

- Press  (4) to access the Settings menu.
- Use **[NAVIGATE/ENTER/VOLUME]** (9) to navigate to the "DRC" menu item.
- Confirm the selection by pressing **[NAVIGATE/ENTER/VOLUME]** and choose your preferred setting.

7.6 Station sequence

By default the radio sorts stations into alphabetical order. You can also sort by signal strength or ensemble. To change the sorting order, proceed as follows:

- Press  (4) to access the Settings menu.
- Use **[NAVIGATE/ENTER/VOLUME]** (9) to navigate to the "Station order" menu item.
- Choose between "Alphanumeric", "Ensemble" and "Valid" and confirm your selection by pressing **[NAVIGATE/ENTER/VOLUME]**.

8. FM

From the main menu or after pressing **[M]** repeatedly, activate operating mode **FM (FM Radio)** on the radio.

Stations that broadcast additional information regarding the station and the programme, are highlighted on the display with an RDS icon (Radio Data System).

This additional information is displayed by pressing .

8.1 Scan setting

The search run setting allows you to determine whether stations with low signal strength are ignored during the automatic search run. Proceed as follows:

- Press  (4) to access the Settings menu.
- Use **[NAVIGATE/ENTER/VOLUME]** (9) to navigate to the "Scan setting" menu item.
- Confirm the selection by pressing **[NAVIGATE/ENTER/VOLUME]**.
- To have the search run stop only at stations with high signal strength, select **Strong stations only**. Otherwise, the search run will stop at every station for which a signal is received.

Note

By default, the "Strong stations only" method is selected. 

8.2 Search / Automatic search

- Press **[NAVIGATE/ENTER/VOLUME]** to start a station search.
- The radio stops the search and starts playback when it finds a station.
- Press **[NAVIGATE/ENTER/VOLUME]** again to continue the search until the next station is found.

8.3 Presets

You can save up to 30 of your favourite stations for quick and direct access.

8.3.1 Assigning the Presets shortcut buttons

- Set the station that you would like to save as a favourite station preset.
- Once the station is playing, press and hold the relevant shortcut button for around 3 seconds.
- The selection will be confirmed by the display showing "Preset (1-4, depending on shortcut key) stored".
- During playback, the Preset memory slot is displayed at the right-hand edge of the screen.

Note

Favourites cannot be deleted. If all 30 station memory slots are filled and you wish to save a new station, choose one of the occupied slots. The station in this slot will be overwritten with the new station. 

8.3.2 Calling up shortcut button presets

To call up a preset station, press the corresponding shortcut button **(2-5)**.



8.3.3 Assigning the list of presets (1-30)

- Set the station that you would like to save as a favourite station preset.
- If the station is playing, press and hold **[H]** (3) for approx. 3 seconds until the Presets list opens up.
- Navigate to the preferred memory slot and confirm your selection by pressing **[NAVIGATE/ENTER/VOLUME]** (9).
- The selection will be confirmed by the display showing "Preset (1-30, depending on storage space) stored".

8.3.4 Calling up a station from the Presets list (1-30)

- Press **[H]** to call up the Presets list.
- Use **[NAVIGATE/ENTER/VOLUME]** (9) to navigate to the preferred station and confirm your selection by pressing **[NAVIGATE/ENTER/VOLUME]**.

8.4 Audio setting

For some stations with a weak signal, quality can be slightly improved by playing them in mono quality. You can enable this function in the menu, and the radio will automatically switch to mono reception when signal quality is poor. To change the audio setting, proceed as follows:

- Press **[G]** (4) to access the Settings menu.
- Use **[NAVIGATE/ENTER/VOLUME]** (9) to navigate to the "Audio setting" menu item.
- Confirm the selection by pressing **[NAVIGATE/ENTER/VOLUME]** and choose your preferred setting.

9. CD player

The radio features a CD drive that can be used to play normal discs (audio CDs, CD-Rs, CD-RWs, MP3 CDs, etc.).

9.1 Insert/Eject disc

Note



Make sure that the disc (CD, CD-R, CD-RW, MP3 CD etc.) is free of dust, dirt, fingerprints and scratches. Otherwise a malfunction may occur during playback, or playback cannot be started. Never use force to insert or eject a disc. This can cause damage to the disc or drive.

Note



Please be aware that, at very high volumes, the playback of the CD may jump or skip

Warning



8-cm CDs (often available as CD singles in the 1990s) or other special formats that differ in diameter or shape from a standard CD cannot be played. Do not try to insert such discs! The drive may be damaged and/or rendered unusable if this warning is disregarded.

- From the main menu or after repeatedly pressing **[MODE]**, activate CD mode on the radio.
- Press **[Eject/Enter]** (16) to open the CD drawer.
- If necessary, remove the disc from the CD drawer.
- Now carefully place a disc in the empty CD drawer.
- Press **[Eject/Enter]** (16) to close the CD drawer.

9.2 Additional functions

- Press **[Play/Pause]** (14) to start playback or press the button during playback to pause.
- Press **[Play/Pause]** to stop the track on the disc being played.
- Press **[Next/FF]** (15) to skip to the next track. Pressing and holding the button initiates fast forward.
- Press **[Back/Rewind]** (12) to skip to the previous track.
- Pressing and holding the button initiates rewind.



10. Playback from external storage media (USB)

- Insert the storage device (such as a USB stick) into the USB port (16) on the radio.
- The storage medium should be formatted as a FAT16 or FAT32 volume.
- Via the main menu or by repeatedly pressing **[MODE]**, activate USB mode on the radio.
- The files and folders saved on the storage medium are displayed. Use **[NAVIGATE/ENTER/VOLUME]** to choose the desired file and begin playback

11. Bluetooth

You can pair your terminal device with the radio using Bluetooth and use it as a playback device. You can control playback directly on the terminal device. You can adjust the volume on the radio, as well.

Note Bluetooth®



- Check whether your mobile device (smartphone, tablet PC, etc.) is Bluetooth capable.
- Note that the maximum range for Bluetooth® is 10 metres without obstacles such as walls, people, etc.
- The connection may be disrupted by other Bluetooth® devices/connections in the vicinity.
- It is only possible to connect the radio to one terminal device.
- Note that compatibility depends on the supported Bluetooth® profiles as well as the Bluetooth® versions being used. (see: Technical data, operating manual of the device being used)

- By repeatedly pressing **[MODE]**, activate Bluetooth® mode on the radio.

11.1 Bluetooth® pairing

- Make sure that your Bluetooth® capable terminal device is switched on and that Bluetooth® is activated.
- By repeatedly pressing **[MODE]**, activate Bluetooth® mode on the radio.
- Open the Bluetooth® settings on your device and wait until the list of found Bluetooth® devices shows **DR1550CBT**.
- If necessary, start searching for Bluetooth® devices on your device.
- Select **DR1550CBT** and wait until radio is listed as connected in the Bluetooth® settings of your device.
- Your device is also shown as connected on the radio display.
- Start and control audio playback using the controls of the device.

Note Bluetooth® Password



- Some devices require a password in order to connect to another Bluetooth® device.
- If your device requests a password to connect to the radio, enter **0000**.

11.2 Automatic Bluetooth® connection (after successful pairing)

- Devices already paired with the radio are automatically saved on the radio.

Note Connection impaired



- After a successful first connection between the radio and device, the connection is established automatically. If the Bluetooth® connection is not restored automatically, check the following:
- In your device's Bluetooth® settings, check that **DR1550CBT** is connected.
 - If not, repeat the steps listed under Bluetooth® pairing.
 - Check that your device and the radio are less than 10 metres apart. If not, move them closer together.
 - Check whether obstacles are impairing the range. If so, move the devices closer together.



11.3 Terminating the Bluetooth® connection

- Ensure that you are in Bluetooth mode.
- Press [Settings] (4) to access the Settings menu.
- Use [VOLUME/ENTER/NAVIGATE] to navigate to the "Terminate connection" menu item
- Then turn [VOLUME/ENTER/NAVIGATE] to select the YES button and confirm the termination of the Bluetooth connection by pressing [VOLUME/ENTER/NAVIGATE].

12. Sleep

The radio has a timer function, which switches the radio to standby mode after a pre-defined length of time, regardless of its operating mode.

- Press [⚙️] (4) to access the Settings menu.
- Use [NAVIGATE/ENTER/VOLUME] (9) to navigate to the "Main menu" menu item.
- Confirm the selection by pressing [NAVIGATE/ENTER/VOLUME].
- Use [NAVIGATE/ENTER/VOLUME] to navigate to the "Sleep" menu item.
- You can set the timer value with [NAVIGATE/ENTER/VOLUME].
- Confirm the setting by pressing [NAVIGATE/ENTER/VOLUME].
- If the sleep timer is activated, this is indicated in the playback screen by [z^zz].

13. Alarms

The Radio has two individually adjustable alarm times.

13.1 Alarm settings

You can access the alarm settings as follows:

- Press [⚙️] (4) to access the Settings menu.
- Use [NAVIGATE/ENTER/VOLUME] (9) to navigate to the "Main menu" menu item.
- Confirm the selection by pressing [NAVIGATE/ENTER/VOLUME].
- Use [NAVIGATE/ENTER/VOLUME] to navigate to the "Alarms" menu item.

Alarm 1 and alarm 2 are configured identically and allow two separate alarm times to be saved. Choose Alarm 1 or 2 and confirm your selection by pressing [NAVIGATE/ENTER/VOLUME].

Set the following details using [NAVIGATE/ENTER/VOLUME].

Mode:

Choose when the alarm is to activate:

Off – Daily – Once – Weekdays – Weekends

Time:

First choose the hour, then the minute at which the alarm is to activate.

Mode:

Set whether you wish to be woken by an alarm tone (**buzzer**) or by **DAB, FM**.

Program:

If you selected **DAB/ FM**, choose which station you wish to be woken with. You can choose any of the 30 preset slots or the **Last listened**.

Volume:

You can set the volume at which the alarm sound should be played. This setting makes it irrelevant how loud you last listened to the radio.

Saving:

Select **Off / On** to complete your alarm settings.

Note

It is recommended to allow the radio to update the time automatically. This ensures that the time is always correct even if there is a separation of power supply – for example a power cut.

13.2 Activating / deactivating the alarm

- Confirm the menu item **Save** in alarm settings to activate the alarm.
- Disable the alarm by setting the **Mode** to **Off**.

13.3 Stopping the alarm/ Snooze function

- When the alarm activates, press [⏸] to stop the alarm.
- When the alarm activates, press [NAVIGATE/ENTER/VOLUME] to enable snooze.
- The alarm turns off for the selected time interval (5/10 minutes) before activating once again.

14. System settings

You can modify all settings and access important information about the radio in the System settings.



14.1 Time/ Date settings

To access the time settings, proceed as follows:

- Press  (4) to access the Settings menu.
- Use **[NAVIGATE/ENTER/VOLUME]** (9) to navigate to the "System settings" menu item.
- Confirm the selection by pressing **[NAVIGATE/ENTER/VOLUME]**.
- Use **[NAVIGATE/ENTER/VOLUME]** (9) to navigate to the "Time/Date" menu item.
- Confirm the selection by pressing **[NAVIGATE/ENTER/VOLUME]**.
- Use **[NAVIGATE/ENTER/VOLUME]** to navigate to the "Auto update" menu item.

Update from DAB / FM

If automatic time and date adjustment is activated, the device receives time and date information from the station over the FM/DAB/DAB+ radio network. This is the best way to ensure that the clock will run accurately and the alarm will trigger at the correct time, even after power outages.

No update

The time and date (**DD-MM-YYYY**) must be set manually; no automatic calibration takes place.

Time/ Date settings

Set the date (**DD-MM-YYYY**) and time (**hh:mm**) manually using **[NAVIGATE/ENTER/VOLUME]**.

Format

Choose between 12 and 24 hours format.

14.2 Language

The first time it is used, the radio's default language is English. To change radio's menu language, proceed as follows:

- Press  (4) to access the Settings menu.
- Use **[NAVIGATE/ENTER/VOLUME]** (9) to navigate to the "System settings" menu item.
- Confirm the selection by pressing **[NAVIGATE/ENTER/VOLUME]**.
- Use **[NAVIGATE/ENTER/VOLUME]** to navigate to the "Language" menu item. Confirm the selection by pressing **[NAVIGATE/ENTER/VOLUME]**.
- Use **[NAVIGATE/ENTER/VOLUME]** to select your preferred system language.
- The language setting currently selected is marked with an asterisk (*).



Note



The following languages are available:
English, Danish, German, French, Italian.

14.3 Factory Reset

To reset the radio to the factory default settings, proceed as follows:

- Press  (4) to access the Settings menu.
- Use **[NAVIGATE/ENTER/VOLUME]** (9) to navigate to the "System settings" menu item.
- Confirm the selection by pressing **[NAVIGATE/ENTER/VOLUME]**.
- Use **[NAVIGATE/ENTER/VOLUME]** (9) to navigate to the "Factory reset" menu item.
- Confirm the following prompt with **YES** to reset the radio to the factory default settings. All settings made previously are deleted.
- To abort the deletion process, press  or select **NO**.

Note



Resetting to the factory default settings can solve some problems and malfunctions.

- However, all settings made previously, such as equaliser and presets, permanently deleted.

14.4 Software update

Improvements and new features are always constantly being developed for the software used in our radios to resolve potential errors, increase the range of functions, and so on. We recommend that you always install any available updates on your radio.

Proceed as follows:

- Press  (4) to access the Settings menu.
- Use **[NAVIGATE/ENTER/VOLUME]** (9) to navigate to the "System settings" menu item.
- Confirm the selection by pressing **[NAVIGATE/ENTER/VOLUME]**.
- Use **[NAVIGATE/ENTER/VOLUME]** to navigate to the "Software update" menu item.
- Select **Automatic updates (YES)** to allow the radio to automatically check for new software updates on a regular basis. (Recommendation)
- Choose **Check now** to manually start a check for software updates.

Warning



- Make sure that the radio has a stable power supply before you start a software update.
- Power supply failure during a software update can cause irreparable damage to the radio.

14.5 Info



To check the current software version, radio ID and device designation of your radio, proceed as follows:

- Press **[⚙️]** (4) to access the Settings menu.
- Use **[NAVIGATE/ENTER/VOLUME]** (9) to navigate to the "System settings" menu item.
- Confirm the selection by pressing **[NAVIGATE/ENTER/VOLUME]**.
- Use **[NAVIGATE/ENTER/VOLUME]** (9) to navigate to the "Info" menu item.
- Confirm the selection by pressing **[NAVIGATE/ENTER/VOLUME]**.

Note



If you require assistance from customer support, please let the agent know the current software version. Problems are frequently resolved through software updates, and your query may be resolved by comparing your software version with the last software version available.

If updates are available, these can be found at www.hama.com with the corresponding article number or designation of the radio.

You may find update instructions in the article's download area.

14.6 Lighting

The backlight can be configured for each operating mode (Operation Mode, Standby Mode) separately.

Proceed as follows:

- Press **[⚙️]** (4) to access the Settings menu.
- Use **[NAVIGATE/ENTER/VOLUME]** (9) to navigate to the "System settings" menu item.
- Confirm the selection by pressing **[NAVIGATE/ENTER/VOLUME]**.
- Use **[NAVIGATE/ENTER/VOLUME]** (9) to navigate to the "Beleuchtung" menu item.
- Confirm the selection by pressing **[NAVIGATE/ENTER/VOLUME]**.
- You can set the brightness with **[NAVIGATE/ENTER/VOLUME]**.

Note



The choice of lighting mode impacts on the power consumption.

15. Care and Maintenance

- Only clean this product with a slightly damp, lint-free cloth and do not use aggressive cleaning agents.
- If you do not use the product for a long time, turn off the device and disconnect it from the power supply. Store it in a clean, dry place out of direct sunlight.

16. Warranty Disclaimer

Hama GmbH & Co KG assumes no liability and provides no warranty for damage resulting from improper installation/mounting, improper use of the product or from failure to observe the operating instructions and/ or safety notes.

17. Declaration of Conformity

CE Hama GmbH & Co KG hereby declares that the radio equipment type [00054874] is in compliance with Directive 2014/53/EU. The full text of the EU declaration of conformity is available at the following internet address:
www.hama.com -> 00054874 -> Downloads.

Frequency band(s)	Bluetooth: 2.402 - 2.480GHz
Maximum radio-frequency power transmitted	4dBm (EIRP)



hama

Hama GmbH & Co KG
86652 Monheim / Germany

Service & Support

 www.hama.com

 +49 9091 502-0

D

GB

The Spotify software is subject to third party licenses found here:
www.spotify.com/connect/third-party-licenses

The Bluetooth® word mark and logos are registered trademarks owned by Bluetooth SIG, Inc. and any use of such marks by Hama GmbH & Co KG is under license. Other trademarks and trade names are those of their respective owners.

All listed brands are trademarks of the corresponding companies. Errors and omissions excepted, and subject to technical changes. Our general terms of delivery and payment are applied.