

00054850
(DIR150BT)

hama



V2

Digital Radio

Digital-Radio

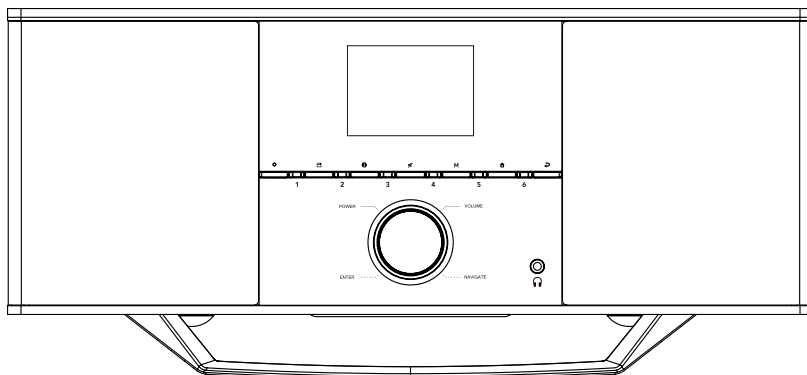

Operating Instructions / Bedienungsanleitung / Mode d'emploi / Instrucciones de uso /
Руководство по эксплуатации / Istruzioni per l'uso / Gebruiksaanwijzing / Οδηγίες χρήσης / Instrukcja obsługi /
Használati útmutató / Návod k použití / Návod na použitie / Manual de instruções / Kullanma kılavuzu /
Manual de utilizare / Bruksanvisning / Käyttöohje / Работна инструкция / Betjeningsvejledning / Manuelt stasjonssøk



1. Table of contents

1. Table of contents	2
2. Introduction	5
2.1 Explanation of warning symbols and notes	5
2.2 Package contents	5
3. Safety instructions	6
4. Information and notes before getting started	8
5. Setting up the radio and accessories	9
5.1 Rear view	9
5.2 Front view	10
5.3 Remote control	11
6. Operating concept	12
6.1 General operation	12
6.2 Settings menu	12
6.3 Managing favourites	13
6.4 Music operation	13
7. Getting started	14
7.1 Remote control	14
7.2 Connecting and operating the radio	14
7.3 Prepare the network connection/Internet connection	15
7.4 LAN connection (wired network)	15
7.5 WLAN/Wi-Fi connection (wireless network)	16
8. Navigation and controls	17
8.1 Control options	17
8.2 Language selection	17
8.3 Setup wizard	17
8.4 Time settings	17
8.5 Keep network connected	18
8.6 Network wizard	18
8.7 Managing favourites	19
8.8 Screen display	20
9. Menu structure	21
10. DAB radio	22
10.1 Station list	22
10.2 Full scan	22
10.3 Delete inactive stations	22
10.4 DRC - Dynamic Range Control	22
10.5 Station sequence	22



11. Internet radio & podcasts23
11.1 Country (based on the IP address of the radio)	23
11.2 History (not yet available or empty during initial setup)	23
11.3 Search	23
11.4 Countries	23
11.5 Popular	24
11.6 Discover	24
11.7 Add stations and create/maintain your own favourites lists (web browser required)	24
11.8 Calling up the administration interface	25
11.9 Add your own stations	26
11.10 Delete stations	27
12. Spotify Connect28
13. Amazon Music29
14. Music player (USB)31
15. VHF radio32
15.1 Automatic station search	32
15.2 Manual station search	32
15.3 Settings	32
16. AUX In (playback from external sources)33
17. Bluetooth® playback (RX)34
17.1 Connect a source device	34
17.2 Music playback via Bluetooth®	34
17.3 More settings	34
18. Routines35
18.1 Sleep	35
18.2 Alarm clock	35
18.3 Timer	36
19. System settings - Overview37



20. Network & Audio	38
20.1 Internet settings	38
20.1.1 Network wizard	38
20.1.2 Connecting to a WLAN	38
20.1.3 Pre-Shared Key (PSK)	39
20.1.4 PIN	39
20.1.5 WPS setup	40
20.1.6 View settings	40
20.1.7 Manual settings	40
20.2 Bluetooth® receiver (BT RX)	43
20.2.1 Bluetooth® receiver	43
20.3 Equaliser	44
21. Screen settings	45
21.1 Display illumination	45
21.1.1 Operating mode	45
21.1.2 Standby mode	45
21.1.3 Snooze mode	45
21.2 Colour scheme	45
22. System	46
22.1 Setup wizard	46
22.2 Time settings	46
22.2.1 Time / date setting	46
22.2.2 Time synchronisation	46
22.2.3 Time display	47
22.2.4 Setting the time zone	47
22.2.5 Summer / winter time	47
22.3 Language	47
22.4 Auto standby	47
22.5 Software update	47
22.6 Factory settings	47
23. About - System information	48
23.1 Info	48
23.2 Privacy Policy	48
24. Technical data	49



2. Introduction

Thank you for choosing a Hama product. Take your time and read the following instructions and information completely. Please keep these instructions in a safe place for future reference. If you sell the device, please pass these operating instructions on to the new owner.

2.1 Explanation of warning symbols and notes

Risk of electric shock



This symbol indicates a risk of electric shock from touching product parts carrying hazardous voltage.

Warning



This symbol is used to indicate safety instructions or to draw your attention to specific hazards and risks.

Note



This symbol is used to indicate additional information or important notes.

2.2 Package contents

- "DIR150BT" Digital Radio
- Remote control
- 2 x AAA (micro) batteries
- Mains power supply
- Jack Cable
- Quick-start guide (multi-lingual)

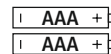
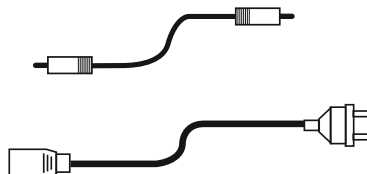
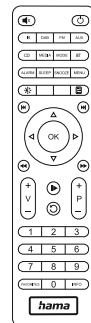
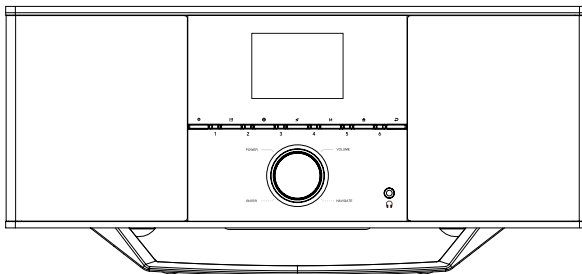



3. Safety instructions

- The product is intended for private, non-commercial use only.
- Protect the product from dirt, moisture and overheating and use it in dry rooms only.
- As with all electrical products, this device should be kept out of the reach of children.
- Do not drop the product and do not expose it to any major shocks.
- Do not operate the product outside the power limits specified in the technical data.
- Keep the packaging material out of the reach of children due to the risk of suffocation.
- Dispose of packaging material immediately in accordance with the locally applicable regulations.
- Do not modify the device in any way. Doing so voids the warranty.
- Do not use the product in the immediate vicinity of heaters, other heat sources or in direct sunlight.
- Do not use the product in areas in which electronic products are not permitted.
- Only use the article under moderate climatic conditions.
- The product is intended only for use inside buildings.
- Do not use the product in a damp environment and avoid splashing water.
- Route all cables so that there is no risk of tripping.
- Do not bend or crush the cable.
- Always pull directly on the plug when disconnecting the cable, never on the cable itself.

Risk of electric shock



- Do not open the device or continue to operate it if it becomes damaged.
- Do not use the product if the AC adapter, adapter cable or power cable is damaged.
- Do not attempt to service or repair the product yourself. Leave any and all service work to qualified experts.



Warning - Batteries



- When inserting batteries, note the correct polarity (+ and - markings) and insert the batteries accordingly. Failure to do so could result in the batteries leaking or exploding.
- Only use batteries (or rechargeable batteries) that match the specified type.
- Before you insert the batteries, clean the battery contacts and the polarity contacts.
- Do not allow children to change batteries without supervision.
- Do not mix old and new batteries, or batteries of different types or from different manufacturers.
- Remove the batteries from products that are not being used for an extended period (unless these are being kept ready for an emergency).
- Do not short-circuit batteries.
- Do not charge batteries.
- Do not burn batteries.
- Keep batteries out of the reach of children.
- Never open, damage or swallow batteries or allow them to enter the environment. They can contain toxic, environmentally harmful heavy metals.
- Remove spent batteries from the product and dispose of them without delay.
- Avoid storing, charging and using in extreme temperatures and at extremely low atmospheric pressures (such as at high altitudes).

Warning



- High sound pressure!
- There is a risk of hearing damage.
- To prevent any loss of hearing, avoid listening at loud volumes for prolonged periods.
- Always keep the volume at a sensible level. Loud volumes, even over short periods, can cause hearing loss.
- Using this product limits your perception of ambient noise. For this reason, do not operate any vehicles or machines while using this product.





4. Information and notes before getting started

This radio offers you the option of using virtually all of the functions conveniently in combination with a smartphone or tablet. To do this, download the free UNDOK app (for iOS & Android).

Note on the UNDOK app

A detailed description of the UNDOK app and all of its functions can be found in our UNDOK Guide at: www.hama.com -> 00054850 -> Downloads

Note – Optimising reception

- For best reception, ensure that the antenna is fully extended and vertical.
- Try various different positions if necessary to get the best reception.



5. Setting up the radio and accessories

5.1 Rear view

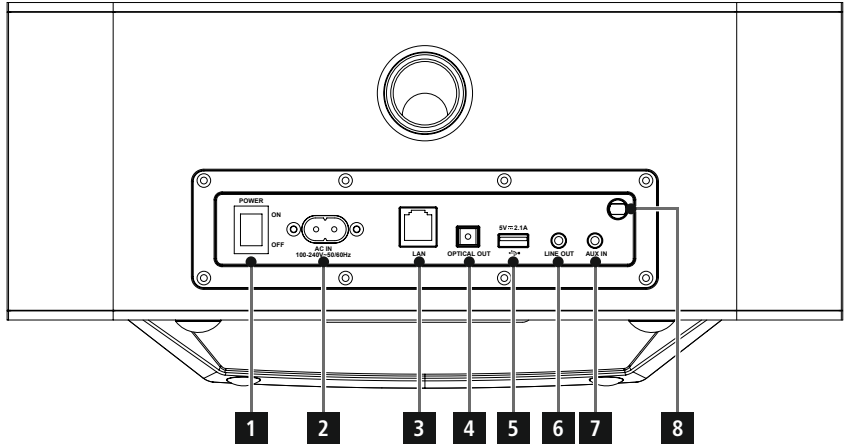

No.	Designation	Function
1	Power switch	Disconnects the radio completely from the mains when switched off
2	Mains connection	Connection of the enclosed mains adapter to the power supply
3	Ethernet / LAN	Connection to the home network via RJ45 patch cable
4	Optical digital output SPDIF	Serial interface for optical transmission of signals to other devices
5	USB connection	- Connection of USB storage media with FAT 16/32 formatting for playback of audio content - Charging port for smartphones/tablets and other USB devices (max. 5V / 2.1A)
6	Line out (3.5mm)	Analogue connection with external loudspeakers and other audio devices via 3.5 mm audio cable
7	Aux in (3.5mm)	Analogue connection with external audio sources via 3.5mm audio cable
8	Antenna	Antenna for receiving DAB/VHF signals



5.2 Front view

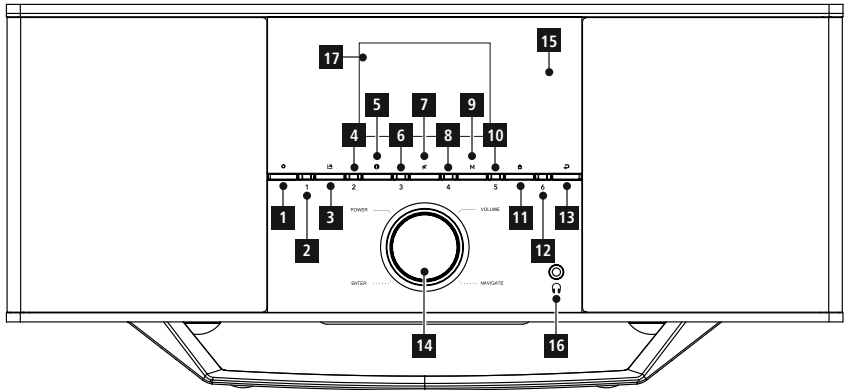

No.	Button	Designation
1		[SETTINGS/MENU] button
2	1	[PRESET 1] button
3		[MEMORY] button
4	2	[PRESET 2] button
5		[INFO] button
6	3	[PRESET 3] button
7		[MUTE] button
8	4	[PRESET 4] button
9	M	[MODE] button
10	5	[PRESET 5] button

No.	Button	Designation
11		[HOME] button
12	6	[PRESET 6] button
13		[BACK] button
14		[POWER] button** / [VOLUME] / [ENTER] / [NAVIGATE]
15		Infra-red receiver
16		Headphone socket
17		2.8" colour display



SETTING UP THE RADIO AND ACCESSORIES

5.3 Remote control

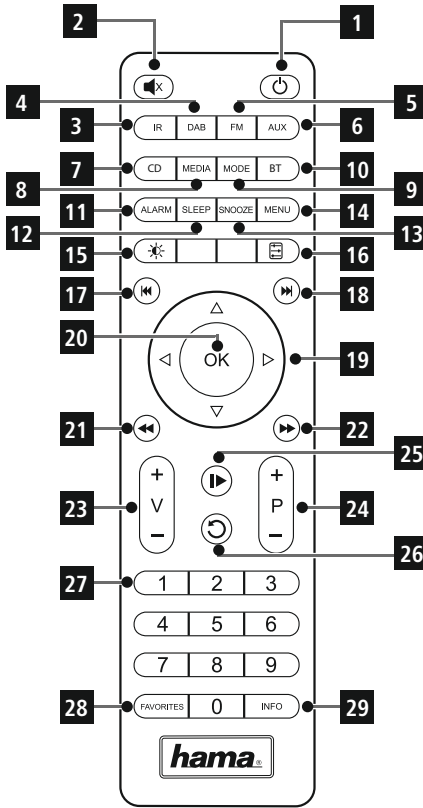

No.	Button	Designation
1		Power
2		Mute
3		Internet radio
4		DAB radio
5		FM/VHF radio
6		AUX-In
7		CD playback mode
8		Media player (USB)
9		Mode
10		BT playback mode
11		Alarm clock
12		Sleep timer
13		Sleep
14		Menu
15		Adjust backlight
16		Equaliser
17		Previous track
18		Next track
19		Navigation buttons left, right, up, down
20		OK
21		Rewind
22		Fast forward
23		Increase / reduce volume
24		Next / Previous favourite
25		Continue / Pause
26		Back
27		Favourites buttons 1-10
28	FAVORITES	List of favourites
29	INFO	Information

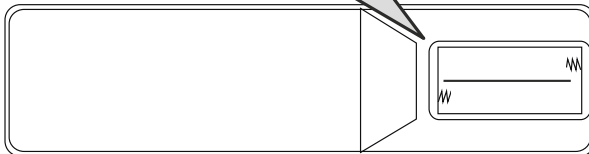
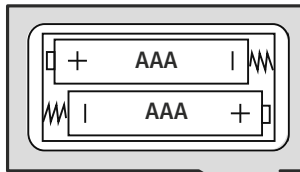



6. Operating concept

6.1 General operation

Icon	Designation	Function
	Hand symbol	Press once
	Hand symbol	Press multiple times
	Hand symbol	Press repeatedly
	Hand symbol	Hold for 3 seconds

Button	Remote control	Designation	Function
		Rotary knob Navigation	<ul style="list-style-type: none"> • Navigation forwards in the current menu • Navigation backwards in the current menu • Reduces the volume of the current playback • Increases the volume of the current playback
		Rotary knob [OK] button	<ul style="list-style-type: none"> • Confirmation button for opening the menu or function currently highlighted • Toggling between the presentation forms available (full screen / split screen) • Long key press: Switch off and switch on the radio
	INFO	[INFO] button	Changes the contents shown in the station information (genre / artist / information)
	MODE	[MODE] button	Repeated pressing toggles between operating modes
	INFO	[HOME] button	All menus are closed and the radio returns to the playback screen

6.2 Settings menu

Button	Remote control	Designation	Function
	MENU	[SETTINGS] button	Opens the Settings menu for the currently active mode
		[BACK] button	<ul style="list-style-type: none"> • Opens the station search / station list (DAB) • Toggles between the setting for the volume and manual frequency setting (VHF) • Back to the previous menu



6.3 Managing favourites

Button	Remote control	Designation	Function
	1	[PRESET 1] button	<ul style="list-style-type: none">• Short key press: Access favourite storage space 1 for current playback mode• Long key press: Save the current station to favourite storage space 1
	2	[PRESET 2] button	<ul style="list-style-type: none">• Short key press: Access favourite storage space 2 for current playback mode• Long key press: Save the current station to favourite storage space 2
	9	[PRESET 6] button	<ul style="list-style-type: none">• Short key press: Access favourite storage space 7 for current playback mode• Long key press: Save the current station to favourite storage space 7
	FAVORITES	[PRESETS] button	<ul style="list-style-type: none">• Short key press: Calls up the favourites list to select favourites• Long key press: Calls up the favourites list to save the selected station

6.4 Music operation

Button	Remote control	Designation	Function
		[PLAY / PAUSE] button	<ul style="list-style-type: none">• The current playback is stopped and the current position in the playback is saved• Pressing the button again continues playback
		[PREVIOUS] button	The current track is started from the beginning. Pressing the button again calls up the previous track
		[NEXT] button	The next track on the storage medium is played
		[MUTE] button	Disables the sound and re-enables it if pressed again



7. Getting started

7.1 Remote control

- Open the battery compartment cover located on the rear of the remote control.
- Insert the batteries provided, making sure you match the polarities correctly. The correct polarity is indicated by the plus and minus symbols in the battery compartment.

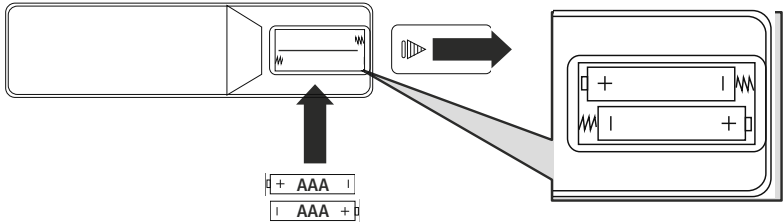

7.2 Connecting and operating the radio

Warning



- Only operate the product from an approved socket that is connected to the public power supply. The socket must be installed close to the product and must be easily accessible.
 - Disconnect the product from the power supply using the On/Off switch – if this is not available, unplug the power cord from the socket.
 - If using a multi-socket power strip, make sure that the total power consumption of all connected devices does not exceed the power strip's maximum throughput rating.
 - If you will not be using the product for a prolonged period, disconnect it from mains power.
- Connect the network cable to a properly installed and easily accessible network socket.
 - The power supply unit is suitable for mains voltages between 100 and 240 V, and is thus operable on almost any AC power grid. Please note that a country-specific adapter may be necessary.
 - You can find an appropriate selection of Hama products at www.hama.com.

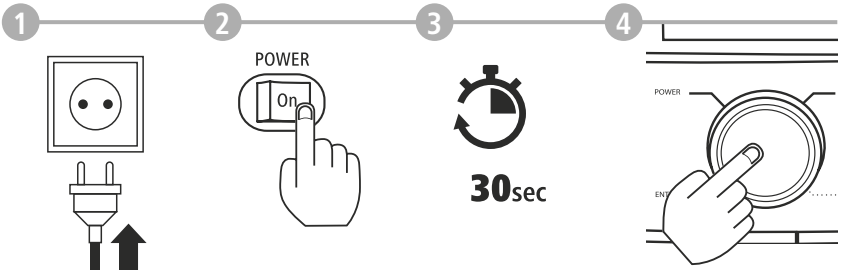

Once the product has been connected to mains power, initialisation takes place. The radio starts up.



7.3 Prepare the network connection/Internet connection

You can integrate this radio into a local network. To receive internet radio or access non-local media (streaming, such as Spotify Connect), the network must be connected to the internet.

Note

The LAN connection is less susceptible to faults than a WLAN connection. That's why it's recommended to use a wired connection between access point (AP) and radio to ensure an undisturbed reception.



7.4 LAN connection (wired network)

- Connect an RJ45 LAN cable to a free socket on your router / switch / AP.
- Connect the other end of the LAN cable to the radio's LAN socket (RJ45).
- Ensure the router is switched on, is functioning correctly and that there is a connection to the internet/network.
- Follow your router's operating instructions as regards the correct functioning of the WLAN connection.
- A detailed description of how to configure the LAN connection is given in the **Cable connection - DHCP active** section.

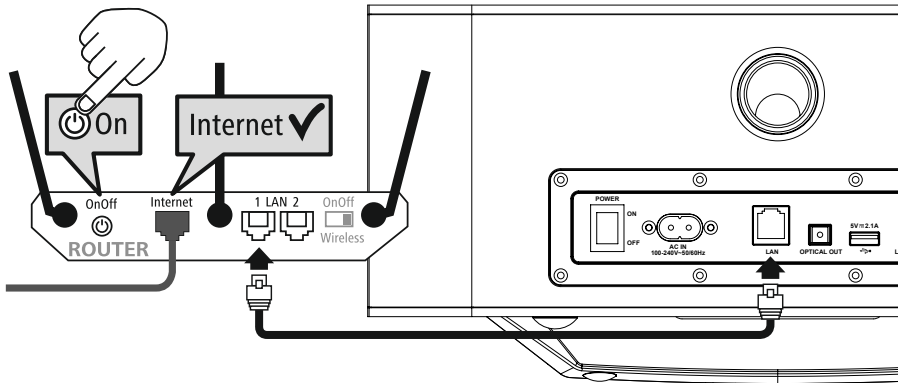

7.5 WLAN/Wi-Fi connection (wireless network)

- Ensure the router is switched on, is functioning correctly and that there is a connection to the internet/network.
- Activate the WLAN function of your router if it is not already activated.
- Follow your router's operating instructions as regards the correct functioning of the WLAN connection.
- A detailed description of how to configure the WLAN connection is given in the **20.1.1 Network wizard** section.

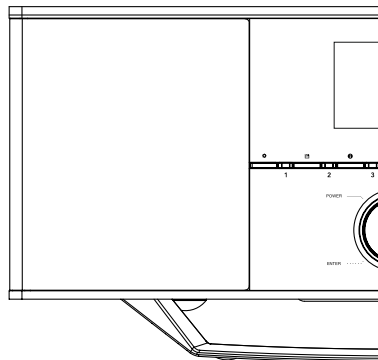
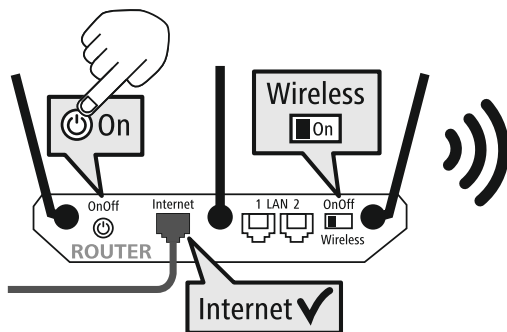



8. Navigation and controls

Once the radio has been initialised for the first time, switch it on using the  button (Power button) if required to start the product setup process. Below, the relevant steps are explained in brief. Further information can be found in the relevant detailed sections.

8.1 Control options

Please see the operating concept for information on the radio's general operation.

The radio can be used with the following control options:

1. Control elements on the device
2. The enclosed remote control
3. The free UNDOK app for Android and iOS devices

8.2 Language selection

Once the initial start-up procedure is complete, you can choose your preferred system language.

Please note that some parts of the interface are synchronised over the Internet and it may be that some sections are not available in your chosen language.

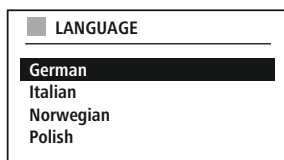

8.3 Setup wizard

We recommend using the setup wizard for quick and easy first-time setup (setting of the time, date, Internet connection, etc.). If you skip the setup wizard's help with first-time setup, you can of course still make these settings via the System settings or re-initiate the setup wizard.

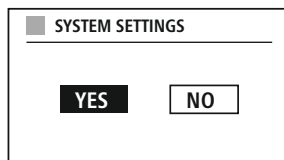

Note on operation

To select between the various settings options, use the control elements explained in the operating concept. These allow you to navigate between the menu items and subsequently confirm your selection. If you have accidentally made an incorrect selection, you can return to the previous menu item.



8.4 Time settings

The radio allows the time to be displayed in 12-hour (am/pm) or 24-hour format. The time can be calibrated using the various reception methods (VHF/DAB/DAB+/Internet), enabling the current time to be synchronised automatically in the event of a power cut. If you disable synchronisation, there is the risk that the time information will need to be repopulated manually after a power cut.





8.5 Keep network connected

This setting is a radio energy-saving function. If the function is switched off, the network function automatically switches to standby mode in order to reduce energy consumption. This means that, when the network function is disabled, the radio cannot be accessed from your PC, smartphone or tablet.

8.6 Network wizard

Using the network wizard will help you connect the radio to the local network or Internet.

Note – Reference to a different part of these operating instructions



Because this chapter is extensive, please follow the directions in section **20.1.1 Network wizard**.

Once the network wizard has finished, the setup wizard is finished as well.

8.7 Managing favourites

Please see the operating concept for information on how to store content for the relevant mode in a storage space and retrieve it. The following storage spaces are available for the reception methods supported:

Digital radio DAB+	30
Analogue radio VHF/FM	30
Internet radio	30
Spotify Connect	10
Amazon Music	8

RECALL FROM PRESET	
1	Antenne Bayern
2	Bayern 3
3	Rockantenne
4	Bayern 1
5	...
6	...
7	...

Save favourites

Remote control

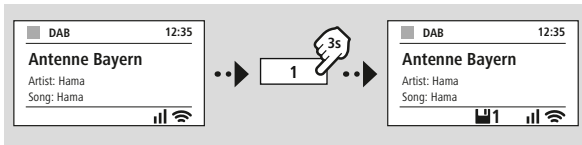

OR

on the product

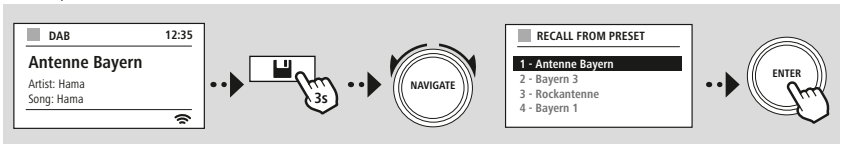

Access favourites

Remote control

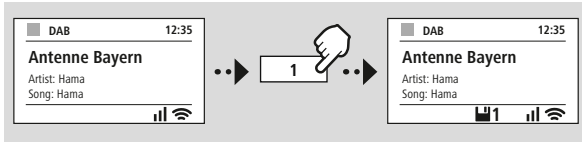

OR

on the product

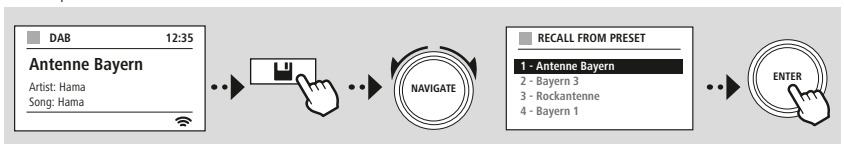



Slideshow



8.8 Screen display

For playback modes that display image content, which can be slideshow content, station logos or album covers, for example, you can choose between different display methods.

- 1) Split screen
- 2) Display of image content on the entire screen

Please refer to the operating concept for the key assignment.

Note



This function is currently only available for Internet radio, DAB radio and Spotify Connect modes.

9. Menu structure

This device has a variety of reception methods and additional functions. These are summarised in the radio's main menu and divided into several sections.

The following overview should help you to find the desired function in the menu structure quickly. The exact explanations are gone into in more detail in the following section and each operation is illustrated graphically.

MAIN MENU

DAB

- Station list
- Scan
- Prune invalid
- DRC - Dynamic Range Control
- Station order

External Sources

- Bluetooth Streaming
- Aux In
- USB

SYSTEM SETTINGS

Network & Sound

- Network
- Bluetooth RX
- Equaliser

Internet radio

- Last listened
- Station list

FM

- Scan setting
- Audio setting

Podcasts

- Last listened
- Station list

Streaming Services

- Spotify
- Amazon Music

Routines

- Sleep
- Alarms
- Timer

Display

- Backlight
- Color Theme

About

- Info
- Privacy policy

System

- Setup wizard
- Time/Date
- Language
- Auto-Standby
- Software update
- Factory reset

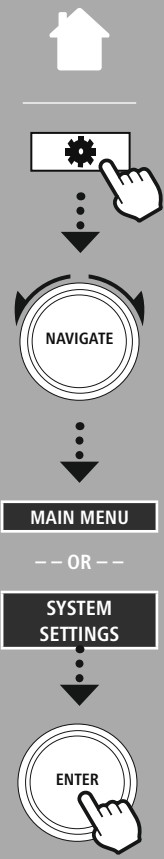



-- OR --

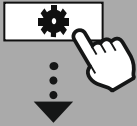

MAIN MENU



DAB

Station list



Station order



10. DAB radio

This radio receives all common digital radio frequencies in the range of 174 MHz to 240 MHz (band III, channels 5A to 13F). The automatic DAB station search starts automatically when DAB mode is started for the first time. As soon as this has been completed, the current station list is displayed.

By calling up the corresponding DAB settings menu, you can access the following settings options and functions.

10.1 Station list

The station list offers a complete display of all radio stations that were found during the last complete search.

Navigate to the desired station you want to call up and confirm this selection. The radio will now start playing the corresponding station.

10.2 Full scan

If the location of the radio changes or if new stations can be received, it is advisable to perform the station search again. The entire frequency range is searched again and the station list is updated.

10.3 Delete inactive stations

Select **"Delete inactive stations"** to remove stations from the station list that are currently no longer available.

10.4 DRC - Dynamic Range Control

Some DAB network radio stations support a volume control feature that actively takes effect during playback. If the volume suddenly increases, DRC automatically lowers it. If the volume suddenly becomes quieter, DRC automatically raises it. The same happens when playback is suddenly quiet. The radio then increases the volume again.

DRC high	Total equalisation of different volumes. Strong compression, can audibly reduce the dynamics of a piece of music
DRC low	Partial equalisation of different volumes. More subtle compression, without too much loss of dynamics
DRC off	No equalisation

10.5 Station sequence

By default the radio sorts stations into alphabetical order. You can also sort by signal strength or ensemble. If sorting by ensemble is selected, the stations are sorted according to the corresponding frequency block on which the respective ensemble is broadcast. These are often frequency blocks which are broadcast locally, regionally or nationally.



-- OR --

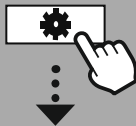

MAIN MENU



Internet radio

Last listened
Station list

Podcasts

Last listened
Station list



11. Internet radio & podcasts

This radio has the ability to play radio stations and podcasts from around the world via Internet radio. When you first enter this mode, the radio displays the possible search and narrowing filters. These can be called up later via the corresponding mode menu.

By calling up the Internet Settings menu, you can access the following settings options and functions.

11.1 Country (based on the IP address of the radio)

When you select this filter, further filters will be displayed to further refine your selection.

Local stations	Stations from your immediate vicinity are displayed.
Popular	Stations that enjoy high popularity within the selected country are displayed.
Genre	Stations are displayed which correspond to the desired genre within the selected country. You can select the desired genre after selecting the filter function. (For example, country, jazz, rock, kids, etc.)
Other	Depending on your location, there may be other filters available, such as by broadcaster for the region.

11.2 History (not yet available or empty during initial setup)

The radio stores the stations called up in this History list - so you can quickly find previously called-up stations again.

11.3 Search

The search function allows you to search specifically for station names or individual keywords.

You can use the on-screen keyboard to enter the search term and then start the search. To do this, select "Done" and confirm this selection. The radio then shows you the matching search results based on the input you have made.

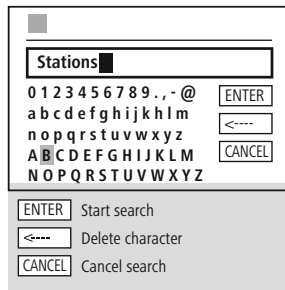
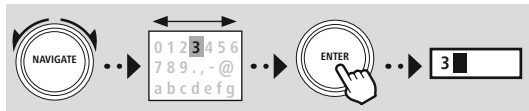

11.4 Countries

With the "Countries" filter function, you have the option of receiving radio from other countries as well. Subsequently, you can refine the search to continents and a corresponding country. Depending on the selected country, further restrictions such as genre, cities or popularity are available.



11.5 Popular

If the search filter **"Popular"** is selected, you will receive a selection of popular stations from the platform provider based on user figures.

11.6 Discover

This function gives you further filter options to refine the selection of suitable search results.

Origin	You can limit the search to the whole world, continents or individual countries.
Genre	The search can be narrowed down to all genres or a specific selection.
Language	Specify which language on which the search results should be based. Here too, you can filter for a specific language or for all languages.

After the preset filters have been selected, select Show channels to display the list of results. The value in brackets tells how many results were found.

11.7 Add stations and create/maintain your own favourites lists (web browser required)

This radio has a locally stored station list which allows you to create your own station lists and add new stations yourself. To use this option, you need a smartphone, tablet or computer that is on the same network and has a web browser.

Note



The radio must be connected to the local network or the Internet and must have a valid IP address.

11.8 Calling up the administration interface

To access the administration interface, you must first determine the radio's IP address on the local network.

To do this, open the Network settings display, which you will find under **System Settings - Network & Audio - Internet Settings - Show Settings**. Now make a note of the IP address displayed there. Alternatively, the IP address can also be determined from the device overview of most routers.

VIEW SETTINGS

IP address
192.168.2.100

Now open the Internet browser on your smartphone, tablet or PC and enter the IP address in the address line of the browser. (e.g. <http://192.168.2.100>)

If the IP address was entered correctly, the radio's administration interface should open.



Language: English ▾

Presets		System & Status
Presets		
Internet radio mode		
Show 10 ▾ entries		
Preset	Name	Action
1		Edit
2		Edit
3		Edit
4		Edit
5		Edit
6		Edit
7		Edit

In the top right-hand corner you will find the supported languages for this interface. Select the desired language from the drop-down menu here.



11.9 Add your own stations

To add or edit a favourite, click Change. The storage spaces of the web administration correspond to those of the radio. Changes on the radio or in the web interface are adopted accordingly.

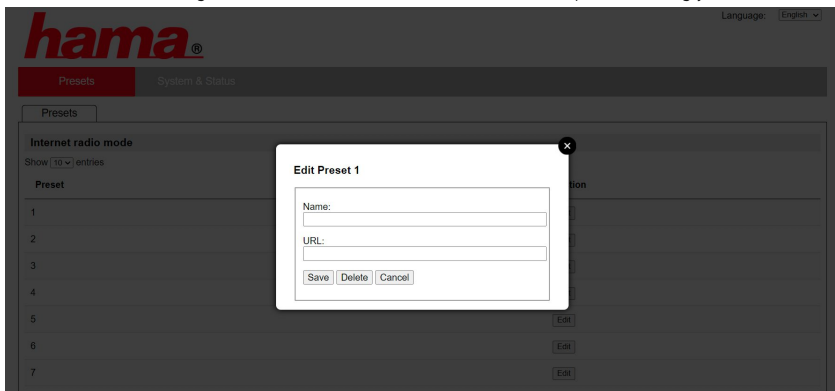

To edit or add a new station, complete the "Name" and "URL" fields and save the change.

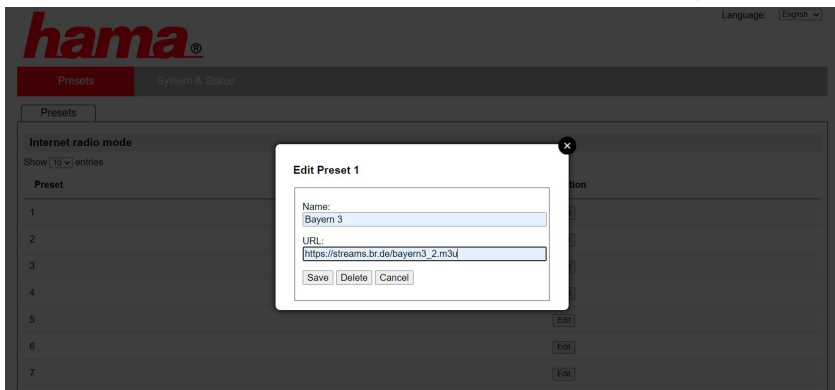

Note

The storage spaces correspond to the storage spaces of the Internet radio.





The added station is now displayed in the radio's favourites list and on the overview page of the web portal. To access the station from the overview page, press **"Play"**.



Language: English ▾

Presets

System & Status

Presets

Internet radio mode

Show 10 ▾ entries

Preset	Name	Action
1	Bayern 3	Play Edit
2		Edit
3		Edit
4		Edit
5		Edit
6		Edit
7		Edit

11.10 Delete stations

To delete a saved station, press the **"Change"** button and then **"Remove"**.

Note

Please note that only stations that offer transmission in AAC or MP3 format are supported.



12. Spotify Connect

Spotify Connect gives you access to millions of songs and brings them to your radio! When you're on the move, transfer music seamlessly back to your smartphone or tablet PC. Save your favourite playlists in the radio's favourites list and start playback without needing your smartphone.

Prerequisites:

- You must have the Spotify app installed on your Android/iOS device or your PC/notebook.
- This can be downloaded from the Google Play or Apple App Store. For the PC, you can get the software from the Microsoft App Store or directly at www.spotify.com
- Once the app is installed, start it and log into your account (or, if you do not have an account, register a new one).

Note

You often get a free trial month of Spotify Premium access when you sign up for the first time. If necessary, check availability at www.spotify.com.

However, this is not a mandatory requirement for this radio and use is also possible with a free account - however, free access entails some restrictions by the provider.

First use:

Before you can save your favourite playlists on the radio, you must link the radio to your account once and save the playlist to a favourites storage location.

Once saved, you can access tracks, albums and playlists without a smartphone. Open the corresponding app/software on your smartphone, tablet or PC and select the corresponding content that you want to transfer to the radio.



Now click on the icon for Spotify Connect. In the following list view, select the Hama digital radio to which you want to transfer the content.

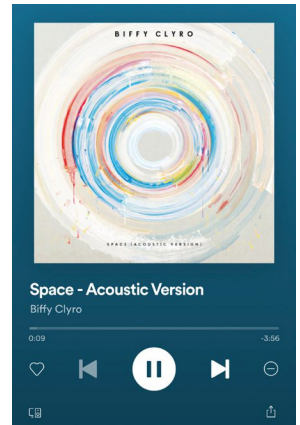

The current playback is now transferred to the radio and continued there.

Using the favourites management options, you can now store this content in the radio's memory and call it up again directly without using the smartphone.

Note

For further information on operating options for the radio, please refer to the operating overview.



-- OR --



MAIN MENU



Streaming Services
Amazon Music



13. Amazon Music

Amazon Music gives you access to millions of songs and brings them to your radio! Find and enjoy your favourite music, playlists or radio stations directly from this radio's integrated user interface

Prerequisites:

- You need a paid Amazon Premium account
- As an Amazon Prime customer, you already have access to a huge selection of music, at no additional cost
- To use the full scope, you will require an Amazon Music Unlimited account (information can be found at www.amazon.de/Music/Unlimited or www.amazon.com/Music/Unlimited)
- To set up your Amazon account, you need the free UNDOK app for Android or iOS devices.

Setup:

- Open the UNDOK app and select the radio in the list of devices.
- In the UNDOK app, select Amazon Music as the source.
- You will now be asked to enter your Amazon login details, which you used to register for Amazon Prime and/or Music Unlimited.
- After you have successfully logged in, the user interface for Amazon Music is available both in the UNDOK app and on the radio.

Note on the UNDOK app

A detailed description of the UNDOK app and all of its functions can be found in our UNDOK guide at:

www.hama.com -> 00054850 -> Downloads



Note

If you want to log out your Amazon account from the device, select the menu item "**Logout**" in "**Amazon Music**" mode. This is possible directly via the radio's user interface or in the UNDOK app.

Use:

- After logging in, you will see the Amazon Music menu.
- This offers numerous search and filter functions with which you can find the right music directly via the radio's menu.
- This menu can be accessed directly from the playback screen .

Saving content:

You can save several contents and call them up directly via the radio's favourites management functions. For information on saving and calling up content, see the operating concept.



Search:

The search function allows you to search specifically for content or individual keywords.

You can use the on-screen keyboard to enter the search term and then start the search. To do this, select "Done" and confirm this selection. The radio then shows you the matching search results based on the input you have made.

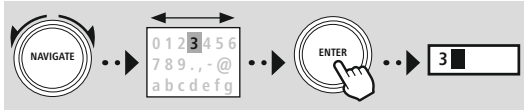
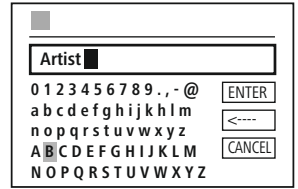

- ENTER Start search
- <---- Delete character
- CANCEL Cancel search

Playlists:

Playlists are a pre-configured compilation of music, often arranged according to a genre, artist or other attributes.

Radio stations:

Radio stations are a dynamic compilation that constantly plays out new content. Compared to playlists, the content is not limited but constantly changing.

My music:

Music that you have added to your favourites via the Amazon Music app or computer software is displayed in this area.

Note

In addition to the listed functions, Amazon Music offers further content, which can change dynamically.
(For example, Football Live, seasonal content, etc.)





-- OR --

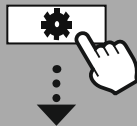

MAIN MENU



External Sources
USB



14. Music player (USB)

The radio has a USB port that allows you to play external storage media.

Please note that only storage media formatted in **FAT16/FAT32 format** are supported - other file systems can lead to problems in recognising the storage medium and prevent playback. The radio supports the playback of **MP3 files**.

Connection

- Connect the storage medium, e.g. a USB stick, to the radio's USB port.
- As soon as the storage medium is connected, it is recognised and initiated by the radio.
- Confirm the prompt asking if you want to open the connected storage medium with **YES**.

Once the storage medium has been initiated, the radio will display the user interface from which you can use the playback functions.

This menu can be accessed again at any time.

USB playback

This menu shows you all the audio files and subdirectories contained on the connected storage medium. Select the file or directory required to start playback.

To add a track to a playlist, highlight it by pressing and holding the confirmation button. The track will then be added to your local playlist.

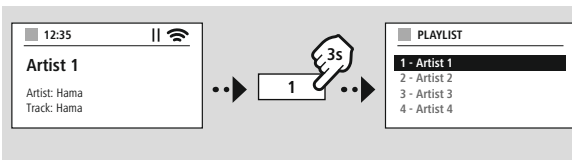

Playlist (up to 200 tracks)

Tracks that were previously added to the playlist are displayed in this menu item. Select the desired track here and start playback.

Repeat (ON/OFF)

If this function is active, the contents of the USB storage medium are repeated.

Shuffle play

If this function is active, the contents of the USB storage medium are played back in a random order.

Empty playlist

Deletes all of the tracks added to the playlist from it. The tracks remain on the storage medium, but the playlist created is completely purged.



-- OR --

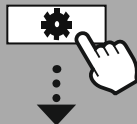

MAIN MENU



FM



15. VHF radio

This radio has a software-based VHF receiver that can receive and play analogue radio. It covers the frequency range from 87.5 MHz to 108 MHz.

15.1 Automatic station search

The radio automatically searches for stations that can be played back with sufficient quality. As soon as a station is found, the search stops automatically and playback starts. Start the search again to search for the next available station.

15.2 Manual station search

- To tune into a station manually, first switch to tuning mode.
- Tuning now takes place in steps of 0.05 MHz.
- Once you have set the frequency, you can switch back to the radio's volume setting.
- If manual tuning is active, the currently set frequency is highlighted on the screen.

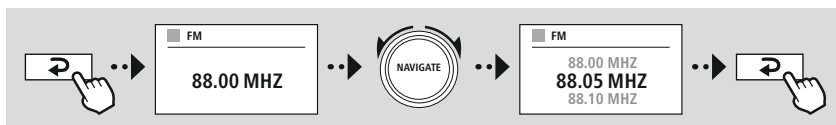

15.3 Settings

Additional functions are available to optimise the quality of playback and the reliability of the search.

• Search settings

Confirm the selection with **"YES"** to play only stations that can be received by the radio in sufficient quality. Select **"No"** to also stop at stations which can only be received in weak quality.

• Audio setting

With analogue radio signals, the radio may try to automatically calculate and play back a stereo quality reproduction. If there are audible quality problems during playback, select **"YES"** to play back the signal unchanged in mono quality.

By selecting **"NO"**, the conversion to a stereo signal is carried out automatically.

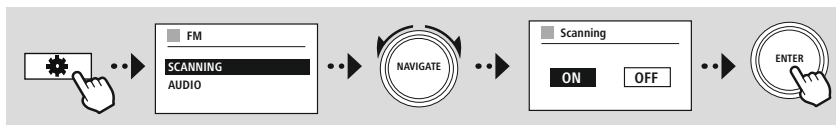

16. AUX In (playback from external sources)

This radio has a 3.5mm jack connection that allows you to connect external source devices to the radio. Please note that all operations are carried out via the source device. On the radio, you can only change the volume.

Note

- The radio detects whether a device is connected and playback is taking place.
- Occasionally, the input signal may be too weak and the radio may mistakenly go into standby mode.
- If this occurs, deactivate the radio's automatic switch-off mechanism.
- Please note that the radio does not automatically go into standby mode when there is no playback.

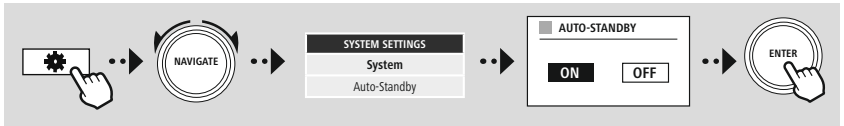



-- OR --



MAIN MENU



External Sources
Bluetooth Streaming



17. Bluetooth® playback (RX)

This radio has a Bluetooth® receiver which allows you to transfer audio content to the radio. The transmitting device, for example a smartphone, is connected to the radio for this purpose and the audio content is transmitted directly to the radio. To do this, activate Bluetooth® playback mode.

17.1 Connect a source device

To pair the radio with a source device, enter the Bluetooth® settings menu and activate pairing via the menu item "Pair new device".

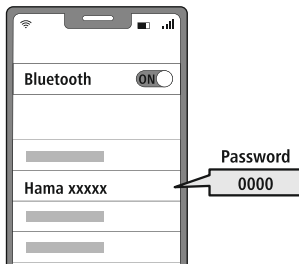
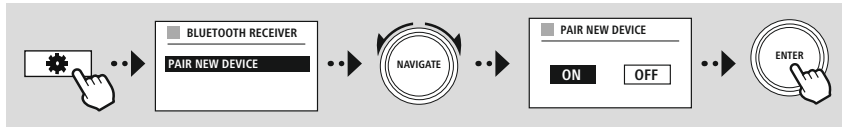

17.2 Music playback via Bluetooth®

As soon as your source device, for example a smartphone, is connected to the radio, start playback on the source device.

The radio now plays back the content. The volume can be changed directly via the radio, but note that the volume must also be adjusted on the source device.

17.3 More settings

To connect a new source device or to disconnect the active connection on the radio, refer to the further information in Section **20.2 Bluetooth® receiver (BT RX)**.



MAIN MENU



Routines



18. Routines

This radio has comfort functions which are available in addition to traditional radio playback.

18.1 Sleep

The snooze function provides you with predefined time intervals from which you can choose. Based on the selection, set a time period after which the radio is automatically switched off.

Note



- If the snooze function is activated, you can make separate settings for the display under Screen settings - Display illumination.
- This allows the brightness, for example, to be reduced.

18.2 Alarm clock

The radio has two individually adjustable alarm times. Alarm 1 and alarm 2 are configured in the same way.

Configuration

First select whether you want to configure alarm 1 or alarm 2 and then specify the exact details:

Status	Set when the corresponding alarm is active.	
	Off	Alarm is inactive
	Daily	The alarm is triggered daily
	Once	The alarm is only triggered once, at the set time
	Saturday & Sunday	The alarm is always triggered on Saturdays and Sundays
Time	Monday - Friday	The alarm is only triggered on Monday to Friday
	Define the date (if "Once" is selected) on which and at what time the alarm is to be active.	
Source	Set which source is to be used for the alarm (radio receiver or signal tone).	
Programme	Set which station (only for alarm via radio receiver) is to be used. You can choose between the last station you listened to or a station that has been saved in a favourite storage space.	
Volume	Set the volume at which the corresponding station or alarm tone is to be played.	
Save	The settings previously made are saved and the alarm is configured.	

**Note**

- If a radio station is selected that is not available at the time of the alarm, the signal tone is played automatically.
- Note that synchronisation of the time is recommended via the Internet or radio so that the time will be resynchronised in the event of a power cut.

18.3 Timer

The timer can be configured to a value of 1-99 minutes.

Select the desired runtime for the timer and then confirm the selection to start the timer. When the timer expires, a signal tone sounds.

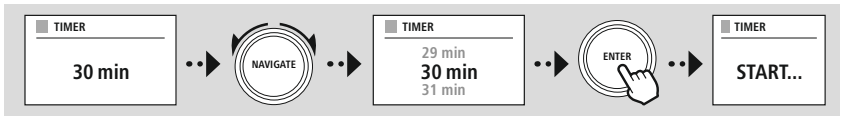

19. System settings - Overview

The system settings are divided into four main categories under which the other settings are located.

Network & Sound	Submenus
Network settings	Network wizard
	WPS Setup
	View settings
	Manual settings
	NetRemote PIN Setup
	Network profile
	Clear network settings
Bluetooth® RX	Keep network connected
	Bluetooth® Receiver
	- Pair New Device - Active Device - Saved Devices
Equaliser	

DISPLAY

Backlight

Color Theme

ABOUT

Info

Privacy policy

System

Setup wizard

Time/Date

Set Time/Date

Auto update

Date/time

Set timezone

Daylight savings

Language

Auto-Standby

Software update

Auto update

Check now

Factory reset

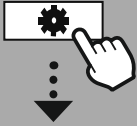

SYSTEM
SETTINGS



Network & Sound
Network



20. Network & Audio

The Network & Audio section contains all the settings options for the radio's connectivity and audio settings. These may include the Internet connection, Bluetooth® receiver/transmitter (depending on the product) and equaliser.

20.1 Internet settings

This menu contains all of the available settings to connect the radio to a wired (RJ45/Ethernet) or wireless network (WLAN 2.4 GHz or 5 GHz).

Note



- Numerous settings can be made conveniently via the app! With the free UNDOK app, you can set up the network connection via your smartphone or tablet.
- More information is available in the free [UNDOK guide](#) from Hama.

20.1.1 Network wizard

- The network wizard guides you through setting up the radio's network and Internet connection.
- Immediately after starting the network wizard, all available connection points in the vicinity are searched for that can be used via the available WiFi frequency bands.
- After the scanning process is complete, the search results are shown on the display and you can choose from the WLAN networks found.
- Alternatively, restart the search using the **"New search"** function or you can connect the radio by cable if it has a corresponding port.

20.1.2 Connecting to a WLAN

Depending on the WLAN network, there are a number of ways to establish the connection to it.

The radio supports open (unsecure!) networks, WPA/WPA2 networks with password/pre-shared key and configuration via WPS (WiFi Protected Setup). Networks that support connection via WPS are identified in the list by the prefix **"WPS"**.

On the following screen, depending on the network, you have the choice between setting up by **"pressing the button"** via Push Button Configuration (PBC) and entering a **"PIN"** and **"Skip WPS"**. If you try to connect to an open WLAN, i.e. without the corresponding security settings, the connection is established immediately after selection.

Note



Setup via WPS by pressing a button is explained in the WPS setup section.



20.1.3 Pre-Shared Key (PSK)

If you have selected **"Skip WPS"**, you will be taken to the input mask for the pre-shared key (PSK), i.e. the password for the WLAN you are trying to connect to. Navigate between the letters (lowercase/uppercase), numbers and special characters to enter your password in the input mask.



PRE-SHARED-KEY (PSK)

Password

0 1 2 3 4 5 6 7 8 9 . , - @	<input type="button" value="ENTER"/>
a b c d e f g h i j k l m	<input type="button" value="←"/>
n o p q r s t u v w x y z	<input type="button" value="CANCEL"/>
A B C D E F G H I J K L M	
N O P Q R S T U V W X Y Z	

The following functions are also available:

<input type="button" value="ENTER"/>	Confirm the input and start the connection setup
<input type="button" value="←"/>	Deletes the last selected character in the input mask
<input type="button" value="CANCEL"/>	Back to the network list <input style="width: 20px;" type="button" value="↩"/>

Once the entry has been confirmed, the radio continues to try and connect. If this is successful, the radio confirms this with **"Connection established"** in the display.

Note



- If the connection fails, this may be because the wrong password was entered.
- Check the configuration of your access point (for example, the router configuration).
- When entering the key, pay attention to uppercase / lowercase letters.

20.1.4 PIN

- If you want to carry out the configuration using a PIN, select the menu item **"PIN"**.
- The radio now generates a key consisting of eight numbers.
- Open the configuration interface of your access point and enter the key in the corresponding input mask and start the connection establishment routine on the access point and the radio.
- Both devices now establish the connection.

Note



Often, the access point's input mask is located in the **"Wireless/WLAN/WiFi"** area - check the router or repeater's operating instructions if necessary.



20.1.5 WPS setup

- If this menu item is selected or if you want to establish a connection by pressing a button via the network wizard, the radio display shows **"Press WPS button on remote station"** after selecting this function.
- Depending on the access point used, a physical button (WPS) is often available or the connection process can be started via the configuration interface.
- Once the process has been started on the access point, please confirm the process on the radio as well.
- The connection will now be established automatically.

Note

If necessary, check the operating instructions of the router or repeater used.



20.1.6 View settings

Shows you the current configuration of the radio on the network.

20.1.7 Manual settings

Cable connection - DHCP active

Select the **"Cable connection"** option and then **"DHCP active"**. The radio now tries to establish a connection via LAN/Ethernet.

Cable connection - DHCP inactive

Select the **"Cable connection"** option and then **"DHCP inactive"**. Now enter the necessary network information such as the IP address, subnet mask and gateway address.

Wireless connection - DHCP active

Select the **"Wireless connection"** option and then **"DHCP active"**. Now enter the exact name of the network (SSID) using the on-screen keyboard.

Then select whether the network is secured (WEP/WPA/WPA2) or unsecured (open). If it is a secure connection, you will be redirected to an input mask with an on-screen keyboard where you must enter the key (PSK) or the password. In the case of an open network, this step is not necessary.

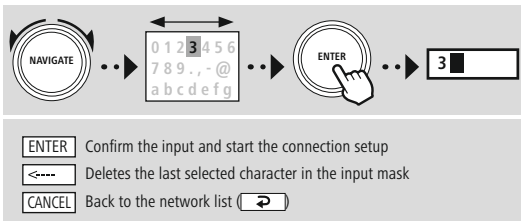

Once the input has been confirmed, the radio will attempt to connect to the network.

SSID

MyHome

0 1 2 3 4 5 6 7 8 9 . , - @ ENTER

a b c d e f g h i j k l m

n o p q r s t u v w x y z <----

A B C D E F G H I J K L M CANCEL

N O P Q R S T U V W X Y Z

PRE-SHARED-KEY (PSK)

Password

0 1 2 3 4 5 6 7 8 9 . , - @ ENTER

a b c d e f g h i j k l m

n o p q r s t u v w x y z <----

A B C D E F G H I J K L M CANCEL

N O P Q R S T U V W X Y Z



Wireless connection - DHCP inactive

Select the "Wireless connection" option and then "DHCP inactive". Now enter the necessary network information such as IP address, subnet mask, gateway address, primary DNS and secondary DNS in the input fields. Once the network data has been entered, enter the exact name of the network (SSID) using the on-screen keyboard.

Then select whether the network is secured (WEP/WPA/WPA2) or unsecured (open). If it is a secure connection, you will be redirected to an input mask with an on-screen keyboard where you must enter the key (PSK) or the password. In the case of an open network, this step is not necessary.

Confirm the input and start the connection setup
 Deletes the last selected character in the input mask
 Back to the network list

IP ADDRESS

IP address
192.168.2.100

Subnet mask
255.255.255.0

SSID

MyHome

0 1 2 3 4 5 6 7 8 9 . , - @
a b c d e f g h i j k l m
n o p q r s t u v w x y z
A B C D E F G H I J K L M
N O P Q R S T U V W X Y Z

PRE-SHARED-KEY (PSK)

Password

0 1 2 3 4 5 6 7 8 9 . , - @
a b c d e f g h i j k l m
n o p q r s t u v w x y z
A B C D E F G H I J K L M
N O P Q R S T U V W X Y Z

Once the input has been confirmed, the radio will attempt to connect to the network.

NetRemote PIN setup

To prevent other users from accessing your radio's configuration, you can assign a network PIN via the input mask. First delete the default PIN "1234" from the input mask and then enter a new four-digit PIN.

Confirm the input and start the connection setup
 Deletes the last selected character in the input mask
 Back to the network list

NetRemote PIN Setup

9876

0 1 2 3 4 5 6 7 8 9 . , - @
a b c d e f g h i j k l m
n o p q r s t u v w x y z
A B C D E F G H I J K L M
N O P Q R S T U V W X Y Z



Network profile

The radio automatically saves all successful network connections (profiles). This means that re-establishing these connections (for example, after the radio was disconnected from the power supply) does not require you to re-enter the network access information.

To remove individual network profiles, select the corresponding network profile and confirm the selection and subsequent prompt with **"YES"**.

Note



A profile that is currently active cannot be deleted.

Delete Internet settings

All previously saved configurations are deleted after confirmation.

Keep internet connection

- This setting is a radio energy-saving function.
- If this function is inactive (NO #), the network module will be switched off whenever the radio is not actively using the network connection (e.g. in standby mode/DAB reception).
- This means the radio will not be accessible via the network from your PC, smartphone or tablet.
- You must activate this menu item (YES #) if you want to use streaming or control functions via the app. This function is deactivated by default.



20.2 Bluetooth® receiver (BT RX)

This radio has an integrated Bluetooth® function that allows streaming (e.g. from a smartphone) on the radio.

20.2.1 Bluetooth® receiver

You can pair your terminal devices with the radio using Bluetooth® and use this as a playback device. You can control playback directly on the terminal device. You can adjust the volume on the radio, as well.

Pair a new device

The radio's mode is changed to Bluetooth playback and the radio is immediately in **"Pairing"** mode. This means that the radio is visible to other devices and you can connect via your smartphone/tablet or other source device. The radio's display shows you the name under which you can find the radio. After a successful connection, you can start playback via the source device.

Active connection

Connected device

Shows you information about the currently connected source device.

Bluetooth® info

Shows you information about the radio's Bluetooth® module (receiver module).

Disconnect

Disconnects the connection to the source device that is currently connected.

Saved devices

Saved devices

Displays a list of the last eight connected source devices. By selecting and confirming an entry, a connection can be re-established or disconnected. If a device is disconnected in this menu, it is also removed from the list of saved devices.

Delete device list

All previously saved devices are deleted from the list.





20.3 Equaliser

The equaliser allows you to adjust the sound of the radio to suit your preferences by amplifying or reducing the amount of bass or treble in the audio .

You can choose from preconfigured profiles, adjusted to suit a variety of music genres, or create your own custom profile.

My EQ settings

To make your own adjustment of the sound, open this menu item and then select whether you want to adjust the bass or treble. After completing the settings, return to the previous menu and then select the profile "My EQ" , which contains your settings.

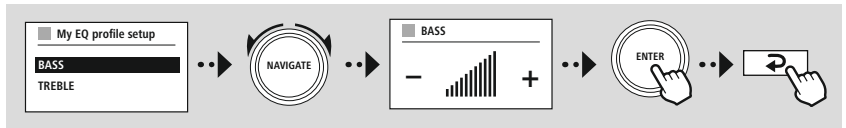



SYSTEM
SETTINGS



Network & Sound
Equaliser



21. Screen settings

21.1 Display illumination

21.1.1 Operating mode

You can choose between "**High**", which corresponds to maximum intensity, "**Medium**" a reduction of the illumination to approx. 60%, and "**Low**", which corresponds to very low intensity.

21.1.2 Standby mode

This setting refers to the radio's standby mode, i.e. when the radio has been set to standby. The "**Timeout (sec)**" function refers to the period of time between switching off the radio and adjusting the lighting intensity. If the timeout function is deactivated, the intensity of the display illumination is adjusted immediately when the radio is put into standby mode.

The "**Display illumination**" menu item allows you to again choose between the values "**High**", "**Medium**", "**Low**" and additionally "**Off**", which completely deactivates the illumination of the display.

21.1.3 Snooze mode

If a snooze function is activated via the Routines function, you can use this menu item to adjust the lighting intensity used during snooze mode. After snooze mode has ended, the radio switches to standby mode and uses the intensity selected accordingly. The values "**High**", "**Medium**", "**Low**" and "**Off**" are available to choose from.

21.2 Colour scheme

This radio has several ready-made colour displays that differ in the colours of the text and the background. Choose your preferred colour scheme here.

Note

Colour scheme 1 is used by default.





SYSTEM
SETTINGS



System



22. System

The radio's general settings are summarised under the System item.

22.1 Setup wizard

We recommend using the setup wizard for quick and easy first-time setup (setting of the time, date, Internet connection, etc.).

The settings included in the setup wizard can of course also be made or adjusted separately. The wizard contains the settings: "**Time format**", "**Time synchronisation**", "**Time zone**", "**Summer and winter time**" and keeping the network connection.

Note

If the setup wizard is used for the first time or is restarted without a network connection set up, the wizard is supplemented with the "**Network wizard**" and the selection of the system language.

22.2 Time settings

22.2.1 Time / date setting

If you want to set the date and time manually, you can do this via the screen mask and confirm the entries one after the other for the day, month, year, hours and minutes.



Note

If the setup wizard is used for the first time or is restarted without a network connection set up, the wizard is supplemented with the "**Network wizard**" and the selection of the system language.

22.2.2 Time synchronisation

When this option is selected, the time and date are synchronised automatically from a radio source. You can select an available radio receiver as the source. If you do not want automatic synchronisation, select "**Do not update**".

Note

If there is a power cut, the radio will request the current time from the selected source and adopt it.

Note

If automatic time synchronisation via the radio signal is selected, the adjustment of the time zone and the manual adjustment of summer and winter time are deactivated and are no longer visible.



22.2.3 Time display

You can choose between the display formats of 24 or 12 hours (am/pm) and adjust this at any time.

22.2.4 Setting the time zone

You can freely choose between the available time zones of Coordinated Universal Time (UTC) and use time zones from -12 hours to +14 hours. For relevant time zones, metropolises and cities are listed after the time zone adjustment.

22.2.5 Summer / winter time

If synchronisation via the Internet has been selected or you want to adjust the manually set time because of the time change, you can activate summer time (YES) or winter time (NO) with this function.

22.3 Language

This menu allows you to change the radio's system language.

22.4 Auto standby

The radio regularly switches to standby mode after 15 minutes without playback in order to save power. Occasionally, there may be problems with playback via a jack connection because the transmitted signal is too weak and the radio mistakenly assumes there is no active playback. To remedy this, you can deactivate automatic standby by confirming the query with **"NO"**.

22.5 Software update

We are constantly developing improvements and new features for our radios to fix problems, add functionality, etc. We recommend that you keep your radio's software up to date.

- Select Auto-Updates (YES) to allow the radio to automatically check for new software updates on a regular basis. (Recommendation)
 - Choose Check now to manually start a check for software updates.
-

22.6 Factory settings

This function allows you to reset your radio to the factory settings on the software side. Confirm the prompt with **"YES"** to start the process.

Note



Resetting to the factory default settings can remedy some problems and malfunctions. However, all settings made previously, such as equaliser presets, station presets and network profiles, will be permanently deleted.



SYSTEM
SETTINGS



About



23. About - System information

This menu provides you with further information about your digital radio and the associated data protection policy, which is provided by the web service provider.

23.1 Info

A summary of the radio's software and hardware. You can find the current software version of your device in this information, should you require support from Hama's product advice team.

23.2 Privacy Policy

The data protection policy is provided by the provider of the web-based applications. Cooperation can be changed within the framework of optimisations and adjustments and possibly another provider may be integrated.



24. Technical data

Technical data	
Display	2.8" (7.11cm) colour TFT 320 x 240 px
Loudspeaker	Tweeter 1" 20W RMS (2x 10W), Satellite 3" 40W RMS (2x 20W), Sub-woofer (Downfire) 4" 30W RMS
Power supply	100 – 240 V ~ 50/60 Hz
Languages supported	English, German, Danish, Dutch, Finnish, French, Italian, Norwegian, Polish, Portuguese, Spanish, Swedish, Turkish, Czech, Slovak
Packaging contents	Digital radio, power cord, remote control, batteries, quick-start manual

Connectivity	
Ethernet	LAN (10/100)
WiFi	2.4GHz (b/g/n) / 5GHz (a/n)
Bluetooth®	receiver (RX): 4.2, Class 1, A2DP, AVRCP
USB (FAT32 file system)	Charge: 5V / 2A Playback: MP3

Audio connections	
Inputs	AUX in 3.5mm
Outputs	Digital optical, headphones 3.5mm, line out 3.5mm

Sources		Favourites
DAB/DAB+ (174.928 - 239.2 MHz)	✓	30
FM (87.5 - 108 MHz)	✓	30
Internet radio	✓	30
Spotify Connect	✓	10
Amazon Music	✓	8

hama

Hama GmbH & Co KG
86652 Monheim/Germany
www.hama.com

Service & Support

 www.hama.com

 +49 9091 502-0

D

GB

**The Spotify software is subject to third party licenses found here:
www.spotify.com/connect/third-party-licenses**

The Bluetooth® word mark and logos are registered trademarks owned by Bluetooth SIG, Inc. and any use of such marks by Hama GmbH & Co KG is under license. Other trademarks and trade names are those of their respective owners.

All listed brands are trademarks of the corresponding companies. Errors and omissions excepted, and subject to technical changes. Our general terms of delivery and payment are applied.