

00054844  
00054851  
(IR350M)

**hama**®

THE SMART SOLUTION

## Internet Radio

## Internetradio

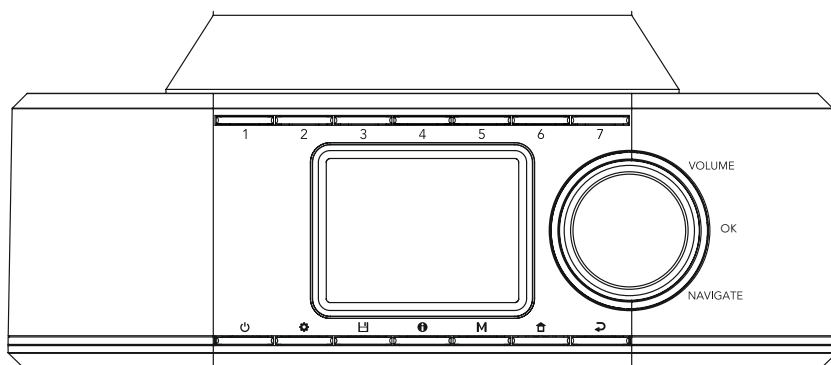

Operating Instructions / Bedienungsanleitung / Mode d'emploi / Instrucciones de uso /  
Руководство по эксплуатации / Istruzioni per l'uso / Gebruiksaanwijzing / Οδηγίες χρήσης / Instrukcja obsługi /  
Használati útmutató / Návod k použití / Návod na použitie / Manual de instruções / Kullanma kılavuzu /  
Manual de utilizare / Bruksanvisning / Käyttöohje / Работна инструкция / Betjeningsvejledning / Manuelt stasjonssøk

Technical data					
<b>Radio Receiver</b>	DAB –	DAB+ –	FM –	Internet ✓	Spotify ✓
<b>Connectivity</b>	WiFi 2.4GHz (b/g/n)				
<b>Display</b>	2.4" (6.1 cm) Colour TFT				
<b>Encryption</b>	WEP, WPA, WPA2, WPS				
<b>Speaker</b>	3"	5 W RMS			
<b>Acoustic Material</b>	Plastic				
<b>Power input</b>	12 V $\overline{=}$ 1 A switch mode power supply				
<b>Power Consumption</b>	Operation	max. 12 W	Standby	< 2 W (network standby)	
<b>Input &amp; Output</b>	DC Socket, Aux in, 3.5 mm Earphone Jack, USB (Update port)				
<b>Presets</b>	Internet: 30	Spotify: 10			
<b>Codec</b>	IR: MP3, WMA, ADTS, MPEG-DASH		UPNP: MP3, WMA, v9/ASF, M4A, ADTS, WAV, LPCM, FLAC, ALAC		
<b>UI Languages</b>	English, German, Danish, Dutch, Finnish, French, Italian, Norwegian, Polish, Portuguese, Spanish, Swedish, Turkish, Czech, Slovak				
<b>Package Content</b>	IR350M, Power Supply, Short Manual, flexible mounting clip, mounting plate				

A

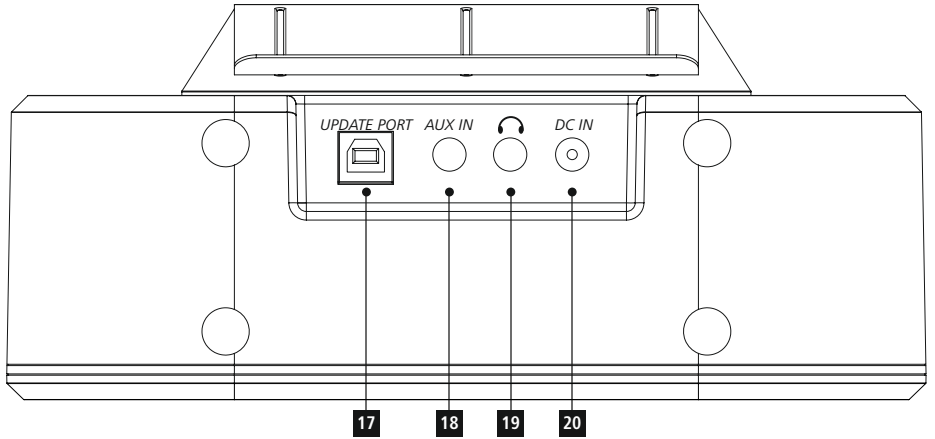
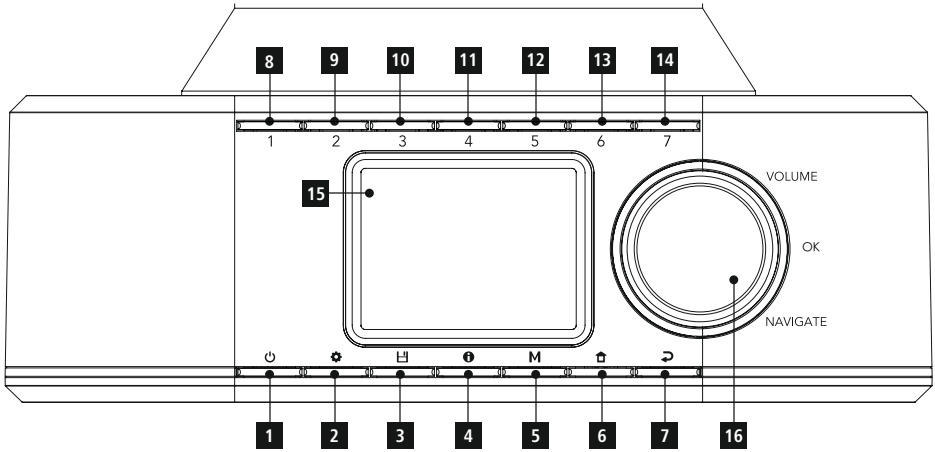

**B** Installation with holding clip / Montage mit Halteklammer

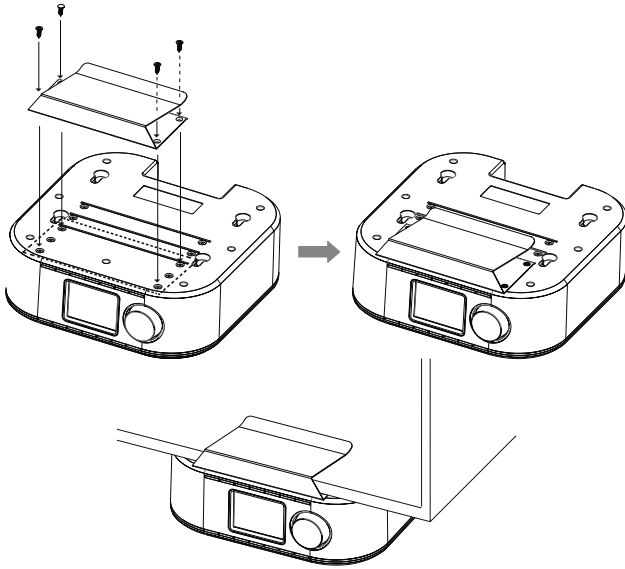



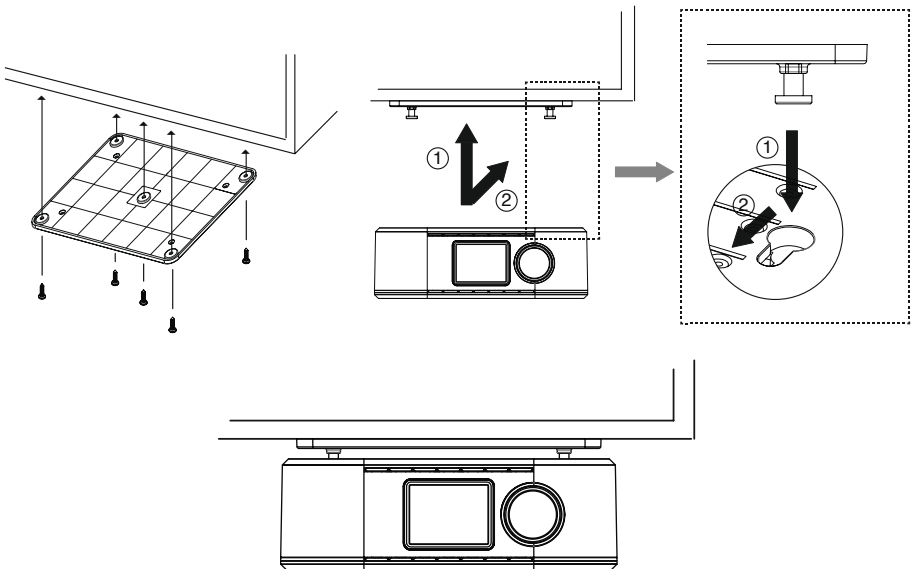





**C** Mounting with connector system / Montage mit Stecksystem



---

## Controls and Displays

A: Radio Front		
1		[POWER]-button
2		[MENU]-button
3		[PRESET]-button
4		[INFO]-button
5		[MODE]-button
6		[HOME]-button
7		[BACK]-button
8-14		[PRESET 1-7]-buttons
15		Display
16		[VOLUME] / [ENTER] / [NAVIGATE]

B: Radio Rear		
17	<i>UPDATE PORT</i>	Update port
18	<i>AUX IN</i>	AUX-In socket
19		Headphone socket
20	<i>DC IN</i>	Mains power supply

<b>1. Explanation of Warning Symbols and Notes</b> .....	<b>3</b>
<b>2. Package Contents</b> .....	<b>3</b>
<b>3. Safety Notes</b> .....	<b>3</b>
<b>4. Installation</b> .....	<b>3</b>
4.1 Installation with holding clip (Clip mount) .....	3
4.2 Mounting with connector system (Screw mount) .....	3
<b>5. General notes on use</b> .....	<b>3</b>
5.1 Navigation and controls .....	4
5.2 Entering passwords, search terms, and so on .....	4
<b>5.3 Additional Information</b> .....	<b>4</b>
5.4 Switching on/off/standby .....	4
5.5 Volume adjustment .....	4
<b>6. Getting started</b> .....	<b>5</b>
6.1 WLAN/WiFi connection (wireless network) .....	5
6.2 Radio – Connecting and starting up .....	5
6.3 Initial setup .....	5
6.4 Setup wizard .....	5
<b>7. Main menu / modes</b> .....	<b>6</b>
<b>8. Internet radio</b> .....	<b>7</b>
8.1 Station search .....	7
8.1.1 Search by country or region .....	7
8.1.2 Search by Genre .....	7
8.1.3 Search by name .....	8
8.1.4 Popular stations .....	8
8.1.5 New stations .....	8
8.1.6 Local stations .....	8
8.2 Podcasts .....	9
8.2.1 Search by country or region .....	9
8.2.2 Search by format (subjects or categories) .....	9
8.2.3 Search by name .....	9
8.3 Last listened .....	9
8.4 Favourites (local) .....	10
8.4.1 Save favourites .....	10
8.4.2 Access favourites .....	10
8.5 Favourites .....	10
8.5.1 First use – Registering your radio .....	10
8.5.2 Managing favourites online .....	11
8.5.3 Opening the favourites list .....	11
8.5.4 My Added Stations .....	11
<b>9. Music player (UPNP, USB)</b> .....	<b>11</b>
9.1 Playback from a computer (streaming) .....	11
9.2 Playback from the network – Accessing files using the radio .....	12
9.3 Playback of Playlist .....	12
9.4 General playback options .....	13
9.5 Access favourites .....	13
<b>10. Auxiliary Input</b> .....	<b>13</b>
<b>11. Sleep</b> .....	<b>14</b>
<b>12. Alarms</b> .....	<b>14</b>
12.1 Alarm settings .....	14
12.2 Activating/ deactivating the alarm .....	15
12.3 Stopping the alarm/ Snooze function .....	15
<b>13. Timer</b> .....	<b>15</b>
<b>14. System settings</b> .....	<b>16</b>
14.1 Equaliser .....	16
14.2 Network .....	16
14.2.1 Network wizard – Configuration of internet connection / Automatic search .....	16
14.2.2 Wireless network connection (WLAN) .....	17
14.2.3 Manual configuration of network connection – wireless (WLAN) and wired (LAN) .....	18
14.2.4 View settings .....	18
14.2.5 Network profile .....	19
14.2.6 Keep network connected .....	19
14.3 Time/ Date .....	19
14.4 Language .....	20
14.5 Factory Reset .....	20
14.6 Software update .....	20
14.7 Setup wizard .....	21
14.8 Info .....	21
14.9 Backlight .....	21
14.10 AUX: Auto-Standby .....	22
<b>15. Spotify</b> .....	<b>22</b>
<b>16. UNDOK – everything in the palm of your hand</b> .....	<b>23</b>
16.1 Multi-room setup on the radio .....	23
16.1.1 General information .....	23
16.1.2 Creating a group .....	23
16.1.3 View details .....	23
16.1.4 Add clients to a group .....	23
16.1.5 List current clients .....	23
16.1.6 Leave group .....	24
16.1.7 Delete group .....	24
<b>17. Care and Maintenance</b> .....	<b>24</b>
<b>18. Warranty Disclaimer</b> .....	<b>24</b>
<b>19. Service and Support</b> .....	<b>24</b>
<b>20. Recycling Information</b> .....	<b>24</b>
<b>21. Declaration of Conformity</b> .....	<b>24</b>

Thank you for choosing a Hama product. Take your time and read the following instructions and information completely. Please keep these instructions in a safe place for future reference. If you sell the device, please pass these operating instructions on to the new owner.

## 1. Explanation of Warning Symbols and Notes

### Risk of electric shock

This symbol indicates product parts energized with a dangerous voltage of sufficient magnitude to constitute a risk of electric shock.

### Warning

This symbol is used to indicate safety instructions or to draw your attention to specific hazards and risks.

### Note

This symbol is used to indicate additional information or important notes.

## 2. Package Contents

- Internet radio "IR350"
- Power supply unit
- Quick Guide
- Clip mount
- Screw mount

## 3. Safety Notes

- The product is intended for private, non-commercial use only.
- Protect the product from dirt, moisture and overheating and use it in dry rooms only.
- As with all electrical devices, this device should be kept out of the reach of children.
- Do not drop the product and do not expose it to any major shocks.
- Do not operate the product outside the power limits given in the specifications.
- Keep the packaging material out of the reach of children due to the risk of suffocation.
- Dispose of packaging material immediately according to locally applicable regulations.
- Do not modify the device in any way. Doing so voids the warranty.

### Risk of electric shock

- Do not open the device or continue to operate it if it becomes damaged.
- Do not use the product if the AC adapter, adapter cable or power cable is damaged.
- Do not attempt to service or repair the product yourself. Leave any and all service work to qualified experts.

## 4. Installation

### Note – Installation location

Choose a suitable position for this purpose because the radio must not be exposed to heat sources or moisture (not above or near a stove/dishwasher/sink).

### 4.1 Installation with holding clip (Clip mount)

- Attach the holding clip on top of the radio with the four included screws. You have the choice between three mounting positions. (Fig. B)
- Simply clip the radio with the mounted holding clip onto the bottom of your wall cupboards. You can simply change the mounting position of the radio this way anytime.
- Check whether the radio is securely attached.

### 4.2 Mounting with connector system (Screw mount)

- Attach the included mounting plate to the bottom of your wall cupboards using all 4 wood screws. (C)
- Mount the radio on the mounting plate so that the 4 pins click firmly into place (fig. C, 1 and 2)
- Check whether the radio is securely attached.

## 5. General notes on use

### Note

A detailed description of the UNDOK app and the full scope of functions can be found in our UNDOK guide at:



[www.hama.com](http://www.hama.com) -> 00054844, 00054851 -> Downloads





## Notes on use

- When a selection among menu items is to be made (such as YES or NO), the one currently selected has a light-coloured background fill.
- In menus offering a variety of different options (such as Equalizer, Update, and so on), the currently selected option is marked with an asterisk (\*).

### 5.1 Navigation and controls

- Select among menu items by turning [**VOLUME/SELECT/NAVIGATE**].
- Confirm the selection by pressing [**VOLUME/SELECT/NAVIGATE**].

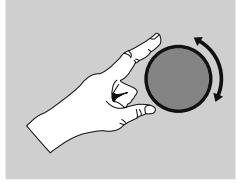
This procedure is indicated in these operating instructions by the following symbols.

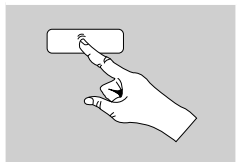
Select (navigate)	Confirm (enter)
	
	Some features can be accessed by means of shortcut buttons. Pressing shortcut buttons is indicated here by this symbol.

After pressing a shortcut button, navigate amongst the menu items using [**VOLUME/SELECT/NAVIGATE**].

### 5.2 Entering passwords, search terms, and so on

- Select each successive letter and digit by turning [**VOLUME/SELECT/NAVIGATE**] and confirm each selection by pressing [**VOLUME/SELECT/NAVIGATE**].
- To make corrections, select – and confirm. The last input made is deleted.
- To cancel input, select **CANCEL** and confirm.
- Once your input is complete, select OK and confirm to finish.
- Press [**info**] to jump directly to the – / OK / CANCEL fields.

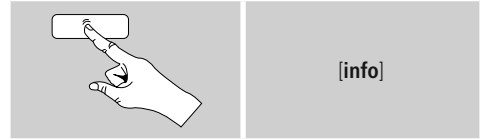

### 5.3 Additional Information

Press [**info**] to display context-dependent additional information. The information shown depends on the operating mode as well as the current selection of radio station, music file, etc.



- **Program genre/country**  
Indicates the genre (music style) and the country or region of the station.
- **Signal strength**
- **Bit rate**  
The current digital bit rate of the station currently being received.
- **Codec**  
Specifies the encoding scheme used to digitise the data or signal (such as MP3 or WMA).
- **Sampling rate**  
Specifies the sampling rate, or the frequency with which the audio signal is polled in a certain period of time.
- **Playback buffer**  
The signal strength of the current station is indicated by the length of the bar display.
- **Today's date**
- **Artist**
- **Album**
- **Folder**
- **Path**  
Specifies the directory path at which the file currently being played back is saved

### 5.4 Switching on/off/standby

- Press [] to turn the radio on or off (standby).
- Press [] to turn the radio on or off (standby).

### 5.5 Volume adjustment

Turn [**NAVIGATE/ENTER/VOLUME**] (16) to increase/reduce the volume.

## 6. Getting started

### 6.1 WLAN/WiFi connection (wireless network)

- Make sure that the router is on and that you have an Internet or network connection.
- If it is not already activated, activate the WLAN network of your router.
- If you have questions about router configuration, please consult the operating manual of the router for troubleshooting.
- A detailed description of how to configure the WLAN connection is given in the **Wireless connection** section.

### 6.2 Radio – Connecting and starting up

Connect the network cable to a properly installed and easily accessible network socket.

The power supply unit is suitable for mains voltages between 100 and 240 V, and is thus operable on almost any AC power grid. Please note that a country-specific adapter may be necessary.

You can find a selection of compatible products at [www.hama.com](http://www.hama.com).

#### Note

- Connect the product to a socket that has been approved for the device.
- When using a multi-socket power strip, make sure that the sum power draw of all the connected devices does not exceed its maximum throughput rating.
- The electrical socket must always be easily accessible.
- If you will not be using the product for a long period of time, disconnect it from mains power.

Once the product has been connected to mains power, initialisation takes place.

The radio starts.

To assist you in first-time setup of the radio, a **Setup Wizard** (6.3) is provided.

### 6.3 Initial setup

When it is first connected to the power supply, a list of available languages for the menu is displayed. Proceed as follows to set your preferred language:

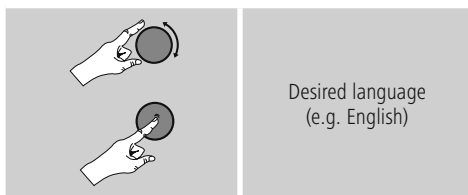

### 6.4 Setup wizard

Once a language has been set, the setup wizard offers to assist you with first-time setup. Choose **YES** to start it or **NO** to skip.

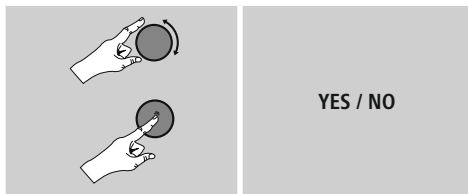

#### Note – Starting with or without the setup wizard

- We recommend using the setup wizard (**YES**) to quickly and easily configure the time, date, internet connection, etc.
- If you wish to skip setup with the setup wizard anyway, choose **NO**. All of the settings configured by the setup wizard can be configured or changed individually in the System settings menu. Alternatively, you may restart the setup wizard at any time.
- Next, choose **YES** or **NO** to define whether the setup wizard should start automatically next time the radio is started up. You are in the main menu.



## Date/time

- **12/24 hour format**

- **Automatic updates**

- **Update from the Internet**

Choose this option to set the time and date automatically from the internet. Set the timezone of your current location and, if desired, turn **ON** automatic adjustment between summer time and winter time.

- **No update**

The time and date (**DD-MM-YYYY**) must be set manually; no automatic calibration takes place.

## Keep network connection

This setting is a radio energy-saving function. If this feature is disabled (**NO#**), the network module will be switched off whenever the radio is not actively using the network connection (such as in standby mode). This means the radio will not be accessible via the network from your PC, smartphone or tablet.

You must enable this menu item (**YES #**) if you want to use streaming or control functions via the app. This function is disabled by default.

## Network wizard – Configuration of the internet connection



**Note – Reference to a different part of these operating instructions**

Due to the large size of this chapter, please refer to **13.2.1. Network wizard – Configuration of the internet connection**

Once the network wizard has finished, the setup wizard is finished as well. The display shows a message to this effect.

Press [**VOLUME/SELECT/NAVIGATE**] to confirm completion and enter the main menu.

## 7. Main menu / modes

Access the main menu as follows:

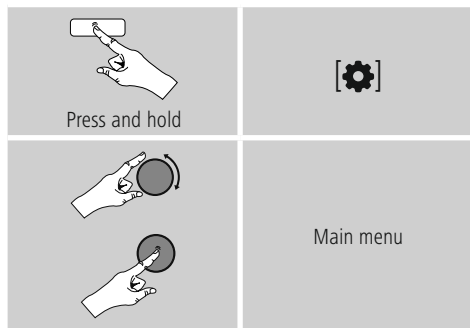

The main menu contains the various operating modes as well as other options that are explained separately in the following chapters.

### 7. Internet radio

### 8. Music player

### 9. Auxiliary Input

### 10. Sleep

### 11. Alarms

### 12. Timer

### 13. System settings

Select amongst the available operating modes by repeatedly pressing [**⏻**] / [**M**].



## 8. Internet radio

### Note

\* If necessary, it is possible to switch providers in order to make all features and functions of the product available.

Enable /[M] operating mode by repeatedly pressing **Internet Radio**.

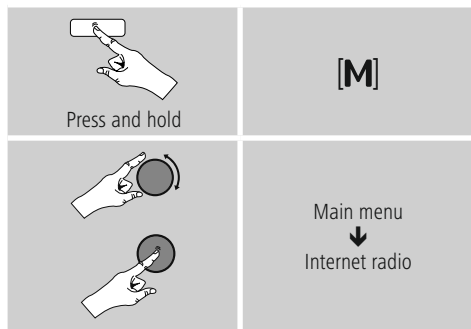

### 8.1 Station search

This radio offers various ways to search for stations.

- Use **[ENTER/NAVIGATE]** to navigate through each search function and its options.
- Once you have found a station you like, confirm by pressing **[ENTER/NAVIGATE]**. The radio starts playing the selected station.

### 8.1.1 Search by country or region

To search for a station by continent, country and region, proceed as follows:

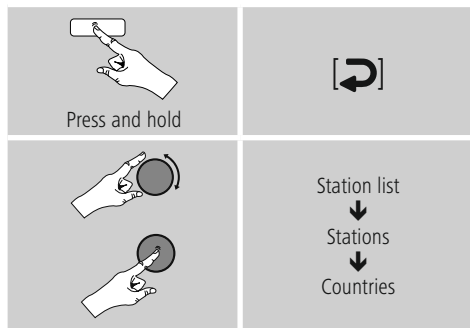

Once you have restricted the results to a certain country or region, select a station from the complete list or from a list sorted by Genre.

### 8.1.2 Search by Genre

To search for a station of a certain Genre or subject focus, proceed as follows:

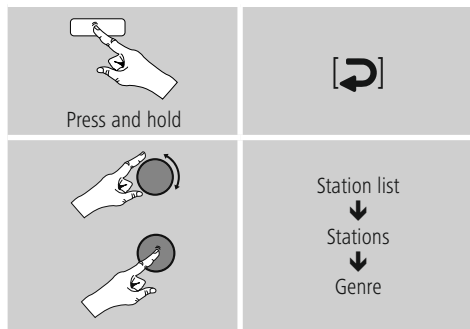

Once you have restricted the results to a certain Genre, select a station from a list of all stations available, or from a pre-selected list, or from a list sorted by country.



### 8.1.3 Search by name

If you know the name of the desired station, you can search for it directly.

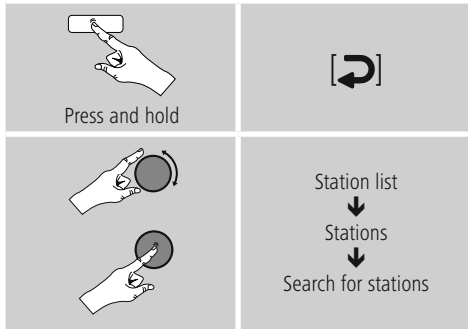

Enter the complete name, or a part thereof, in the input screen and select **OK** to start the search. You receive a list of all available stations whose names contain the search key.

### 8.1.4 Popular stations

You can find a selection of the most popular stations as follows:

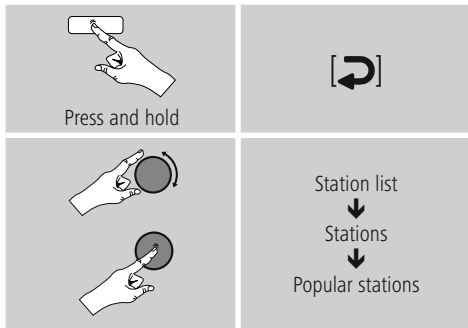

### 8.1.5 New stations

Stations that have recently been added to the database can be found as follows:

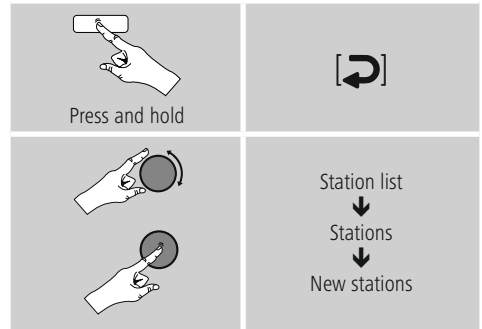

### 8.1.6 Local stations

To search for stations from your own country (the country in which the radio is currently located), proceed as follows:

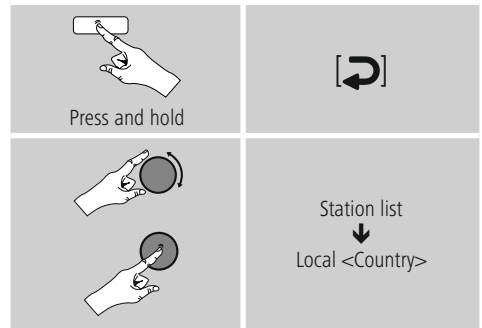

#### Note

Replace the <Country> placeholder with the country you are currently located in.

You can filter this local list by Genre, or select a station from the complete list, or select from a pre-selected list.



## 8.2 Podcasts

Podcasts are programs on various topics and include, for example, talk shows, news and much more. Podcasts can be downloaded from the Internet. There are Normally approximately 10,000 programs available. Similarly to radio stations, the radio makes it possible to filter a large number of Podcasts, or to search the entire database for a matching result.

### 8.2.1 Search by country or region

To search for a podcast by continent, country and region, proceed as follows:

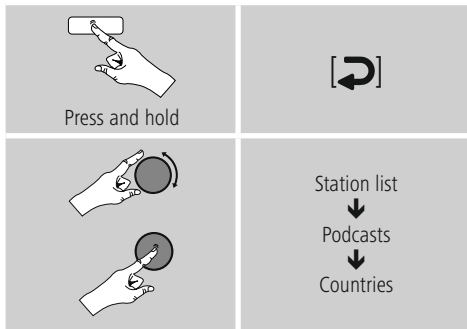

### 8.2.2 Search by format (subjects or categories)

Once you have restricted the results to a certain country or region, select a station from the complete list or from a list sorted by Genre.

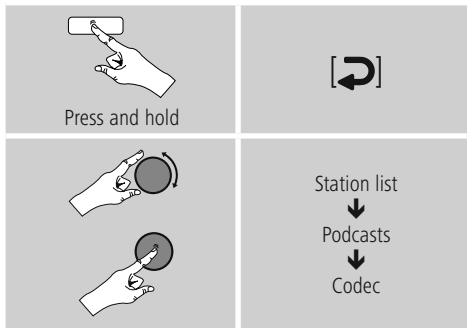

### 8.2.3 Search by name

If you know the name of the desired Podcasts, you can search for it directly.

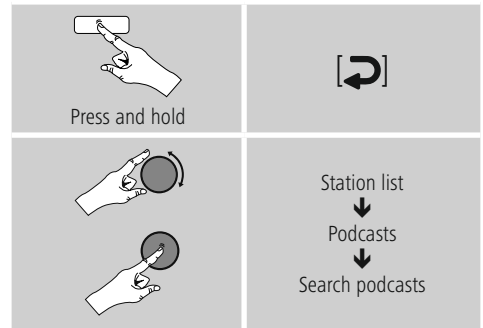

Enter the complete name, or a part thereof, in the input screen and select **OK** to start the search. You receive a list of all available Podcasts whose names contain the search key.

### 8.3 Last listened

The radio saves the last stations and Podcasts listened to in their own list. To access the list, proceed as follows:

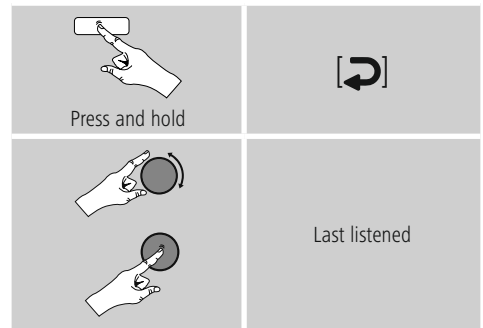

## 8.4 Favourites (local)

You can save up to 30 of your favourite stations for quick and direct access.

### 8.4.1 Save favourites

- Set the station that you would like to save as a favourite station preset.
- If the station is received, press and hold [H] on front of the radio.



An overview window with the station presets should open after approx. 2 seconds.

- You can switch between the station presets (1 to 30) by turning [ENTER/NAVIGATE].
- Press [ENTER/NAVIGATE] to save the station on the desired station preset.

### 8.4.2 Access favourites

Press [H] to open the overview window with the list of saved stations.



Use [ENTER/NAVIGATE] to select one of your favourites.

#### Note

Favourites cannot be deleted. If all 30 station memory slots are filled and you wish to save a new station, choose one of the occupied slots. The station in this slot will be overwritten with the new station.

## 8.5 Favourites

(airable - <http://www.wifiradio-frontier.com>)

In addition to the local favourite memory slots, you can also create your own lists of favourites.

### 8.5.1 First use – Registering your radio

In order to be able to use this function you have to register at [www.wifiradio-frontier.com](http://www.wifiradio-frontier.com). You need a valid email address and an access code which will be generated by your radio.

#### Note

- No personal information is collected during the registration process.
- Registering does not cost you anything extra. The offer is completely free.
- Following registration you can choose from around 20,000 radio stations and 10,000 podcasts.

#### Get access code:

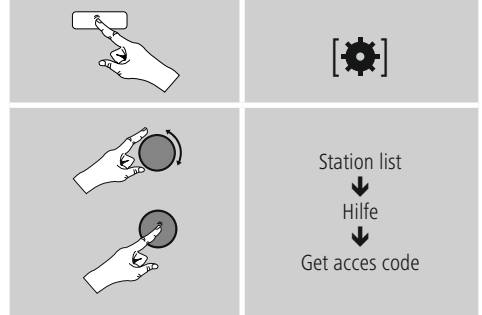

#### Note

Please note that each access code can only be used once. Please contact customer service if you should experience problems while registering the radio.

- During registration, the radio's ID is associated with your e-mail address and saved in the web interface.
- If multiple radios are registered to you and you wish to delete one of those registrations or just compare them, you can find the radio's ID as follows.

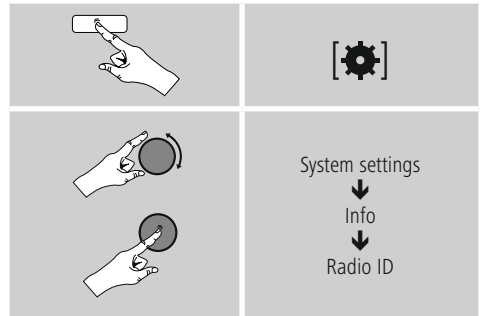

## 8.5.2 Managing favourites online

(airable - <http://www.wifiradio-frontier.com>)

After registering on the portal, you can search through the station archive using various filters, try out stations, and create your own favourites list from the stations listed there. The favourites list is then synchronised with your radio in a matter of seconds.

## 8.5.3 Opening the favourites list

To open the favourites list you created on the portal using the radio, proceed as follows:

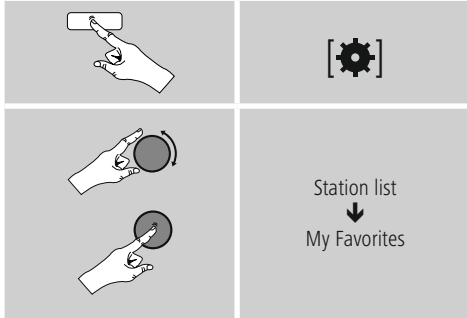

## 8.5.4 My Added Stations

If a station you desire is not yet available, you can add it manually to the portal, or suggest a station be added to the database (Recommend station).

- You need the web address of the stream, which can often be found on the station's website.
- You can access the added radio stations as follows:

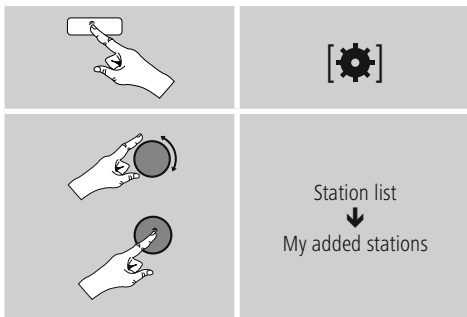

The database is constantly expanded and maintained. Nevertheless, we hope you'll understand that sometimes there can be delays in integrating new stations and some stations are even rejected.

## 9. Music player (UPNP, USB)

This operating mode enables the playback of MP3, WMA or FLAC files stored on a PC, data medium or local network.

Enable [📶]/[M] operating mode by repeatedly pressing **Music player**.

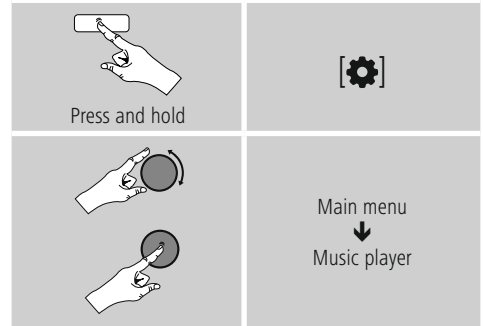

## 9.1 Playback from a computer (streaming)

You can manage the radio and stream music to it from your computer.

The following explanation assumes your computer's operating system is Windows 8. If you use a different operating system and require assistance, or if you have any other questions, please contact our customer **support** team.

### Requirements:

- The radio and the computer must be on the same network.
- The radio must be authorised as a playback device on the computer.

Proceed as follows:

→ **Control Panel** → **Network and Internet** → **View network computers and devices**

The radio should be shown here.

- Right-click on the icon or designation of the radio and choose **Allow streaming to this device**.
- Right-click again on the icon or designation of the radio and choose **Show device website** to change the friendly name of the device.
- A new browser window opens. You can make the desired changes here.



### Use:

- The radio can now access shared directories on the computer, and you can stream audio files to the device for playback.
- The music directory of your music library is enabled as standard.
- Create and manage shared folders using Explorer or Windows Media Player.
- Right-click on the desired music file, choose **Play To**, and then select the designation of the radio.
- The radio begins playback of the music file.

### 9.2 Playback from the network – Accessing files using the radio

To access one of the existing network shared files directly from the radio, proceed as follows:

From the main menu or after pressing **[O]/ [M]** repeatedly, activate **Music player** mode.

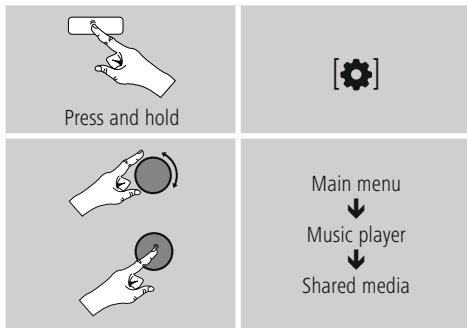

- Choose the correct device (home server, PC, etc.) and press **[ENTER/NAVIGATE]** to open the list of shared folders on that device.

You can now search for files, open a Playlist, or search through the entire shared music folders. If you want to search through the entire selection of music, there are other sorting functions available (Album, Artist, Genre, Folder, etc.) that can help you find the desired file more quickly.

### Note

These functions are only available if the ID3 tag and other file information have been maintained on the source device.

### Prune servers:

To reset the list of servers connected to so far, press **[ENTER/NAVIGATE]**. If you confirm by choosing **YES**, then all Common Media will be deleted.

### 9.3 Playback of Playlist

You can create a local Playlist on the radio, in which you save files shared on the network or from connected data storage devices.

- Under **Shared media/ USB playback**, choose the file to be added to the Playlist.
- Press and hold **[ENTER/NAVIGATE]** for approx. 3 seconds until the display shows the message **Added to Playlist**.

### Note

You can also use Playlists that were created on your Windows PC. (WPL = Windows Playlist). For example, Windows Media Player is suited for this purpose.

- To go directly to the Playlist, do as follows:

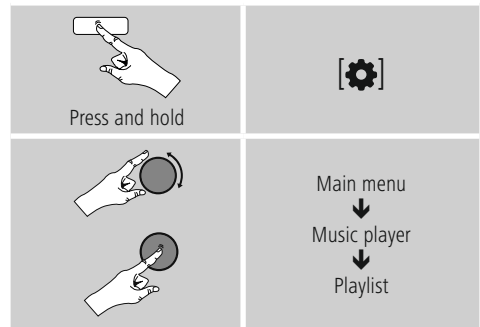

- To remove individual files from the Playlist, choose the file and then press and hold **[ENTER/NAVIGATE]** for approx. 3 seconds.
- Confirm **Delete from My Playlist** by choosing **YES** to delete the file from the Playlist.



- To delete the entire Playlist, proceed as follows:

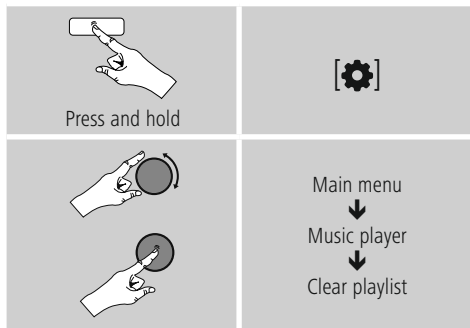

#### 9.4 General playback options

These playback options, which are valid for all playback under Music player, can be found here:

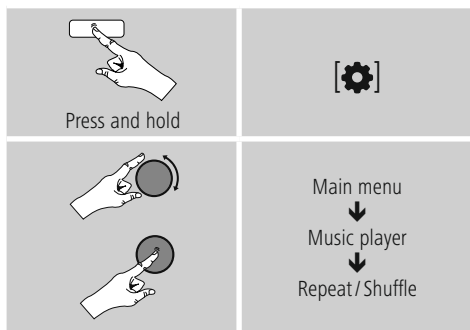

#### Repeat play: On / Repeat play: Off :

To turn the function **On and Off**, press [ENTER/NAVIGATE] repeatedly.

If this function is activated (**Repeat play: On**) the current track is repeated.

#### Shuffle play: On / Shuffle play: Off

To turn the function **On and Off**, press [ENTER/NAVIGATE] repeatedly.

If this function is activated (**Shuffle play: On**) the radio plays all tracks in random order.

#### 9.5 Access favourites

Press [F] to open the overview window with the list of saved stations.



Use [ENTER/NAVIGATE] to select one of your favourites.

#### Note

Favourites cannot be deleted. If all 30 station memory slots are filled and you wish to save a new station, choose one of the occupied slots. The station in this slot will be overwritten with the new station.

#### 10. Auxiliary Input

Via the analogue audio input (**AUX IN** socket) you can connect mobile devices (for example smartphone, tablet PC, M3 player etc.) to the radio and play the audio files using the radio's speakers.

- From the main menu or after pressing [P]/ [M] repeatedly, activate **Auxiliary Input (Aux in)** mode.

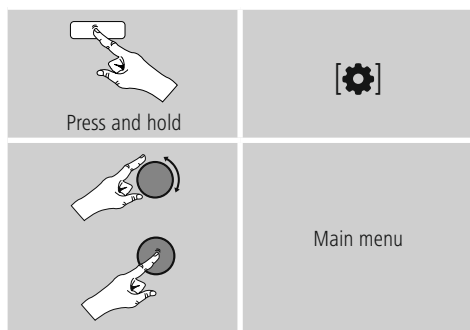

- Connect your mobile terminal device to the audio in (the **AUX IN** socket) of the radio using a 3.5-mm TRS stereo cable.
- Start and control audio playback using the controls of the connected terminal device.



## 11. Sleep

The radio has a timer function, which switches the radio to standby mode after a pre-defined length of time.

- Set the time interval from the main menu using [ENTER/NAVIGATE]:

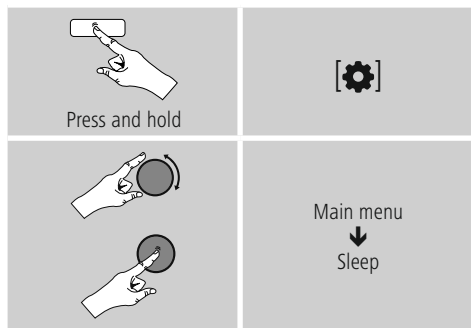

- After the defined time the radio switches to standby mode.
- Press [⏪]/ [M], to turn the radio back on.

### Note

There is a separate setting for the backlight when the timer (snooze) is activated. For example, it can be set to be dimmer than in Normal operation. **13.9. Backlight.**

## 12. Alarms

The Radio has two individually adjustable alarm times.

### 12.1 Alarm settings

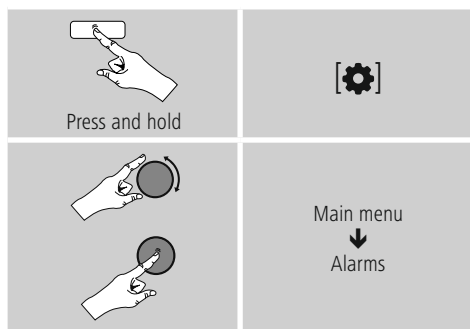

- Alarm 1 and alarm 2 are configured identically. So you can save two different alarm times. Select alarm 1 or 2 and then make the following settings by means of [ENTER/NAVIGATE]:

#### Enable:

Choose when the alarm is to activate:

→ Off – Daily – Once – Weekdays – Weekends

#### Date and time:

If you selected **Once**, enter the date and time for the one-off alarm.

#### Time:

First choose the hour, then the minute at which the alarm is to activate.

#### Mode:

Set whether you wish to be woken by an alarm tone (**Buzz**), or by the **Internet radio**.

### Preset:

If you selected **Internet radio**, choose which station or podcast you wish to be woken with. You can choose any of the 30 favourite station slots or the **Last listened**.

### Volume:

You can set the volume at which the alarm sound should be played. This setting makes it irrelevant how loud you last listened to the radio.

### Save:

Confirm this menu item to complete your alarm settings.

#### Note

- When using **Internet radio** for the alarm sound take care that the internet connection will be available at the time of the alarm. If no internet connection is available the radio instead uses the wake-up buzzer (**Buzz**).
- It is recommended to allow the radio to update the time automatically. This ensures that the time is always correct even if there is a separation of power supply – for example a power cut.

### 12.2 Activating/ deactivating the alarm

- Confirm the menu item **Save** in alarm settings to activate the alarm.
- Disable the alarm by setting the **Mode: to Off**.

### 12.3 Stopping the alarm/ Snooze function

- When the alarm activates, press **[⏏]/ [M]** to stop the alarm.
- The alarm turns off for the selected time interval (5/10/15/30/60 minutes) before activating once again.
- If the alarm is not stopped, the radio automatically switches into standby mode after one hour.
- Hold the **[⏏]/ [M]** button down for approximately 3 seconds to finally stop the alarm.

### 13. Timer

The radio is equipped with an egg timer, which emits an alarm tone after a pre-defined length of time has elapsed.

- Press **[\*]**, select **[Egg Timer]** in the main menu and confirm your selection by pressing **[ENTER/NAVIGATE]**.

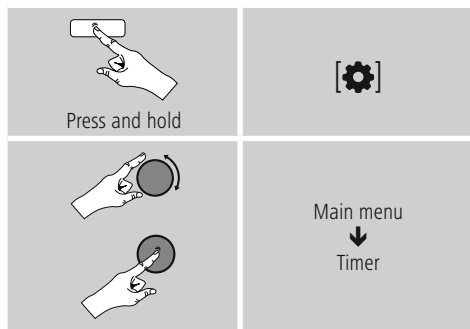

Turn **[ENTER/NAVIGATE]** to select the desired count-down time (0–99 minutes).

- Press **[ENTER/NAVIGATE]** to display the time remaining.
- Once the time interval has elapsed, press **[POWER]** or **[BACK]** to stop the alarm tone. Otherwise, the alarm will stop automatically after 30 minutes.
- Set the time interval to 0 minutes to turn off the egg timer.



## 14. System settings

You can modify all settings and access important information about the radio in the System settings.

### 14.1 Equaliser

The equaliser allows you to adjust the sound of the radio to suit your preferences by amplifying or reducing the amount of bass or treble in the audio. You can choose from preconfigured profiles, adjusted to suit a variety of music Genres, or create your own custom profile.

- To set the Equaliser, proceed as follows:

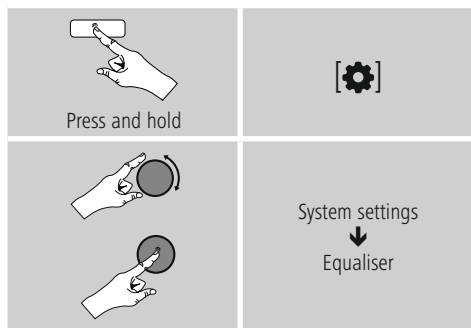

- Use **[ENTER/NAVIGATE]** to choose one of the preconfigured profiles.
- To create your own equaliser profile, choose the option **My EQ profile setup**.
- This takes you to the **bass**, **treble** and **loudness** settings (volume amplification).
- To adjust a particular value, press **[ENTER/NAVIGATE]** at the corresponding menu item and then change the value by turning **[ENTER/NAVIGATE]**. If playback is already started when you modify these settings, you can hear the changes in the audio immediately.
- Confirm your settings by pressing **[ENTER/NAVIGATE]** once more.
- Complete the configuration process by pressing **[↵]** on the device and confirm the saving of settings by pressing **[ENTER/NAVIGATE]**.
- To use the new profile, choose the item **My EQ**.

## 14.2 Network

### 14.2.1 Network wizard – Configuration of internet connection / Automatic search

The **network wizard** supports you to set up a connection between the radio and internet. More methods of configuration and detailed information are amplified subsequently.

- You can start the **Network wizard** as follows:

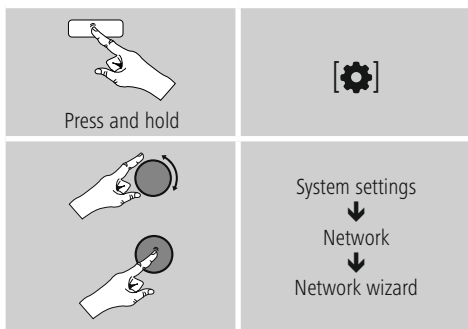

- When the wizard is started, the radio searches for WLAN (WiFi) connections and then shows a list of the available networks.
- Turn **[ENTER/NAVIGATE]** to switch amongst the networks discovered. At the bottom of the list are options to restart the search (**[Rescan]**) or configure the connection yourself (**[Manual config]**).
- If your network is not found or the SSID (Service Set Identification, that is, the name of your network) is not shown, the network may be hidden or out of range. In this case, try manual configuration.

## 14.2.2 Wireless network connection (WLAN)

Depending on the network, there are a number of ways to connect to it. Networks that support connection via WPS (Wi-Fi Protected Setup) are identified in the list as **[WPS]**. Other connections are either open networks or connections protected with a PSK, or Pre-Shared-Key.

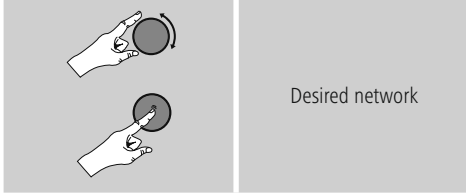

### WPS-/PSK-/ open network connection

WPS allows simple and nevertheless protected connection of the radio to the network. Two options are available for this purpose: The connection can be set up by means of PBC, or Push-Button Configuration, or by the PIN procedure, in which the web interface of your router prompts you to enter a randomly generated sequence of numbers.

#### PBC setup

- Select your desired network. (Indicated by the prefix **[WPS]**).
- In the WPS menu, choose the **Push Button** option and confirm your selection by pressing **[ENTER/NAVIGATE]**.
- Press the WPS button on your router or current access point. This can often be done using the web interface, as well.
- Consult the operating instructions of your router or access point for details.
- Once the process has been started on the router or access point, the radio should be able to find and connect to the network.

- Alternatively, PBC setup can be initiated from the internet settings of the radio:

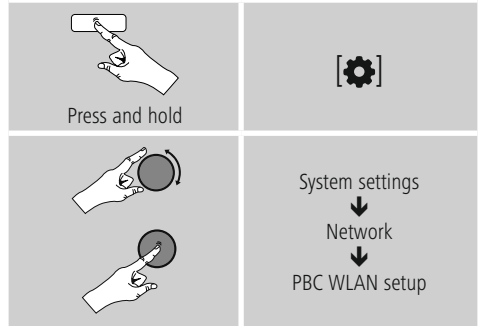

#### PIN setup

- Select your desired network. (Indicated by the prefix **[WPS]**)
- In the WPS menu, choose the Pin option and confirm your selection by pressing **[ENTER/NAVIGATE]**.
- The radio generates an 8-digit code, which must be entered into the web or user interface of your router or access point.
- Consult the corresponding handbook for details on configuring the router or access point.

#### Skip WPS / Pre-Shared Key (PSK) setup

- Choose the item **Skip WPS** to proceed to key entry.
- In networks that do not support WPS, you will go directly to key entry.
- In the input screen, enter the whole key and then confirm with **OK**.
- If the key was entered correctly, the radio connects to the access point and establishes the internet/network connection.

#### Note

- Often the Pre-Shared Key is printed on the back or bottom of the router or access point.
- When entering the key, take notice of capitalisation.



## Open network

### Note

- We recommend against establishing unsecured connections and advise you to always protect your network against unauthorised access.
- If you plan to use an open network, you just have to select the network ID from the list of available networks and confirm. The radio then connects immediately to the network.

### 14.2.3 Manual configuration of network connection – wireless (WLAN) and wired (LAN)

To manually configure the network connection, proceed as follows:

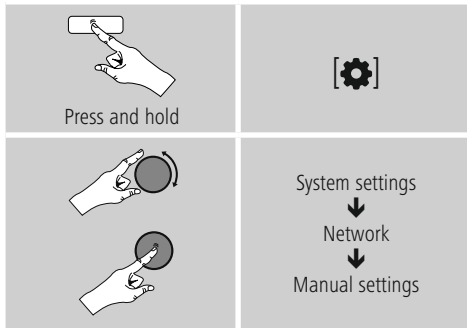

### Manual configuration wireless (WLAN) – DHCP enable

- Select the option **Wireless**.
- Select the option **DHCP enable**.
- In the input screen, enter the whole SSID (network name) and then confirm with **OK**.
- Now choose the security standard used by the network. This can be found in the configuration options of your router or access point.
- Depending on the encryption used, you may need to enter the network key before the connection is established.

### Manual configuration wireless (WLAN) – DHCP disable

The method described here assumes the DHCP server is active (**manual wireless configuration (WLAN) – DHCP enable**). However, the network information such as IP address, subnet mask, gateway address, and DNS (primary and secondary) must still be entered. Find this information in the web interface of your router or access point, or ask your network administrator. Once all the information has been entered correctly, confirm to proceed. The radio now attempts to establish the connection.

### 14.2.4 View settings

Here you can find all the most important information about all network connections currently used or configured on the radio, such as: MAC address, WLAN region, DHCP active/ disabled, SSID, IP address, subnet mask, gateway address, DNS (primary and secondary), etc.

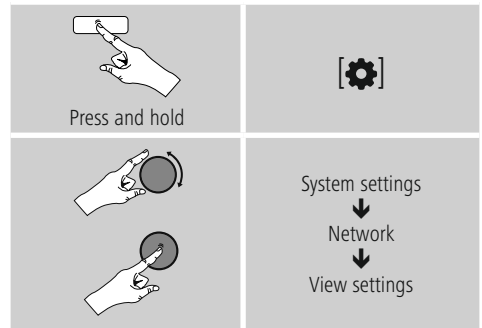

### 14.2.5 Network profile

The radio automatically saves all successfully connected network profiles. This means that re-establishing these connections (for example, after the radio was disconnected from the power supply) does not require you to re-enter the network access information.

- To remove network profiles individually, proceed as follows:

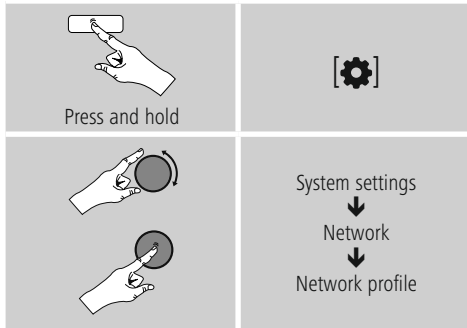

- Select a network profile and press [ENTER/NAVIGATE] to delete it.
- Confirm the prompt querying if you want to delete the profile with **YES**.
- A profile that is currently active, or that is in use, cannot be deleted.

#### Note - Data security

- Before giving or selling the radio to someone else, we recommend performing a **Factory Reset**.
- This will completely and permanently delete all network information and connections stored on the device.

### 14.2.6 Keep network connected

This setting is a radio energy-saving function.

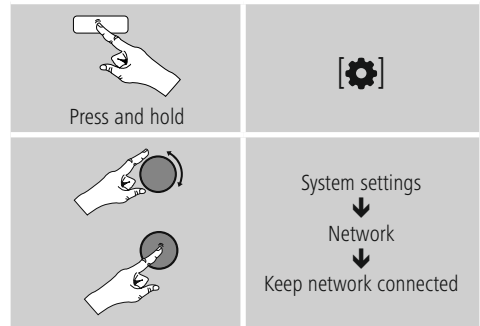

If this feature is disabled (**NO#**), the network module will be switched off whenever the radio is not actively using the network connection (such as in standby mode). This means the radio will not be accessible via the network from your PC, smartphone or tablet. You should enable (**YES #**) this menu item if you want to use streaming or control functions via the app. This function is disabled by default.

### 14.3 Time/ Date

To access the time settings, proceed as follows:

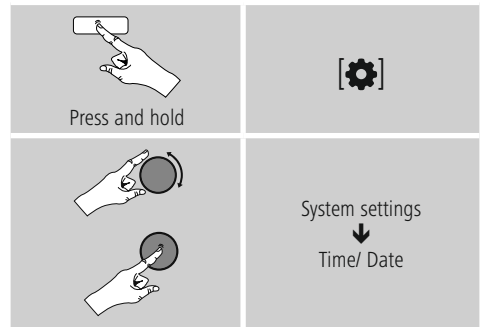

#### Auto update

##### Update from Network

Choose this option to set the time and date automatically from the internet. Set the timezone of your current location (**Set timezone**) and, if desired, turn on automatic adjustment between summer time and winter time (**Daylight savings → ON**).



## 14.4 Language

To change the menu language from that selected at first-time startup, proceed as follows:

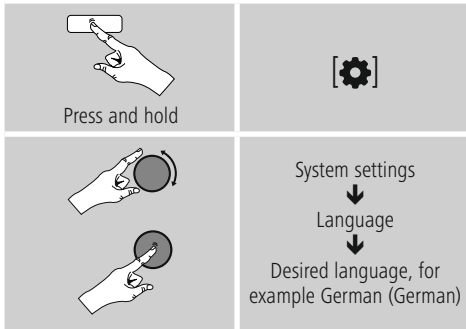

## 14.5 Factory Reset

To reset the radio to the factory default settings, proceed as follows:

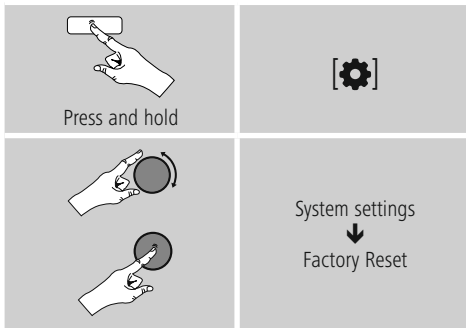

- Confirm the following prompt with **YES** to reset the radio to the factory default settings. All settings made previously are deleted.

### Note

- Resetting to the factory default settings can solve some problems and malfunctions.
- However, all settings made previously, such as custom equaliser presets, favorites, and network profiles, are permanently deleted.

## 14.6 Software update

We are constantly developing new software features and improvements for our radios to fix problems, add functionality, etc. We recommend that you keep your radio's software up to date.

- Proceed as follows:

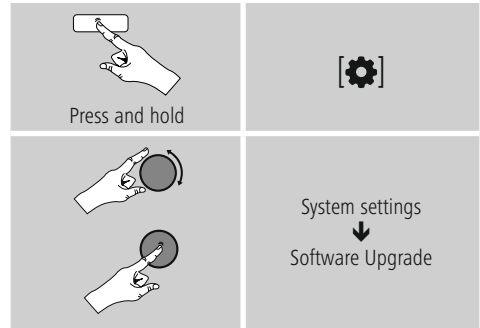

- Set **Auto-check setting to YES** to have the radio automatically check for new software updates at regular intervals. (Recommendation)
- Choose Check now to manually start a **check for software updates**.

### Warning

- Make sure that the radio has a stable power supply before you start a software update.
- Power supply failure during a software update can cause irreparable damage to the radio.



## 14.7 Setup wizard

You can restart the setup wizard (**Setup wizard**) at any time by proceeding as follows:

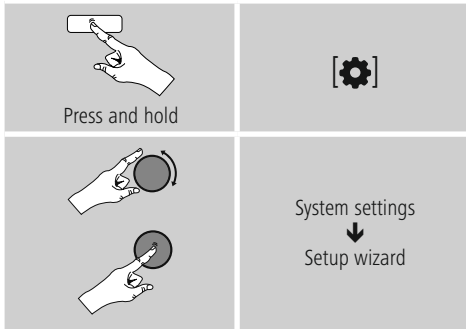

## 14.8 Info

To have the radio display current information about its hardware and software (version numbers, device designation, radio ID, etc.), proceed as follows:

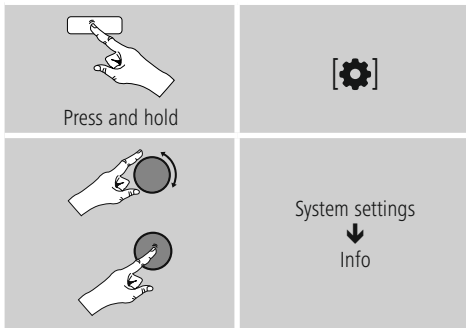

If you have already registered your radio on the online portal of Frontier Silicon (<http://www.wifiradio-frontier.com>), then you can find out the radio ID there, as well.

## 14.9 Backlight

The backlight can be configured for each operating mode (Operation Mode, Standby Mode, Slumber Mode) separately.

Proceed as follows:

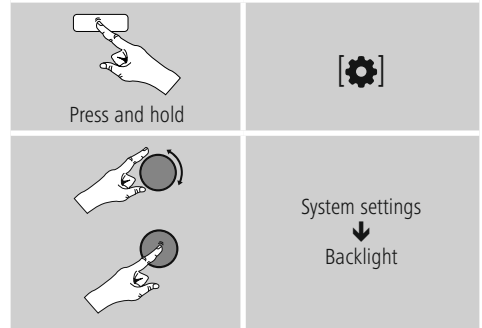

- For the operation modes '**Operation mode**' and '**Slumber mode**', select between various brightness levels.
- For **Standby mode**, you may also choose a brightness level for the backlight when the radio is in standby (**display lighting**). Alternatively, you can set the backlight to turn off completely in standby (**Display lighting** → **Off**).
- Choose a time interval for **Timeout (sec)**. When the radio is in standby, press any button to illuminate the display at the brightness level set for that operating mode for the selected interval of time.
- Alternatively, you can disable this feature (**Timeout (sec)** → **Off**).



## 14.10 AUX: Auto-Standby

In **Aux in (Auxiliary Input)** operating mode, the radio switches to standby mode after 15 minutes, by default. To disable (**NO**) or activate (**YES**) this feature, proceed as follows:

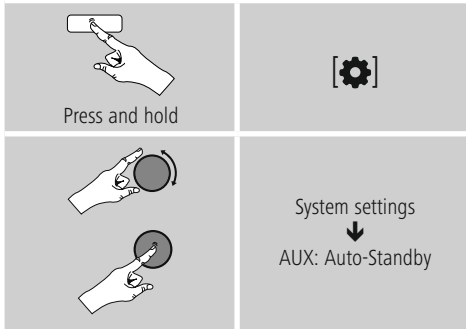



## 15. Spotify

Spotify Connect gives you access to millions of songs. You can listen to them on your radio, on the go using your smartphone, or at your PC.

### Requirements:

- You must have the Spotify app installed on your Android or iOS device.
- It can be downloaded from the Play Store or the Apple App Store. Once the app is installed, start it and log into your account (or, if you do not have an account, register a new one).
- You will require a Spotify Premium account (see [www.spotify.de](http://www.spotify.de) for more information).
- The radio must be on the same network as the Android or iOS device with the Spotify app installed.

### Use:

- In the Spotify app, start playback of a playlist or title as usual.
- The usual playback information is displayed, such as the album cover, title, etc.
- At the bottom edge of the screen, the Spotify Connect logo  is shown next to **Available devices**.
- Choose  **Available devices** to access an overview of all devices available on the network.
- Select the radio. The audio is now played back on the radio.

Once the connection has been established, the Spotify Connect logo  and the device designation are displayed in green.

### After successful initial connection:

From the main menu or after pressing **[mode]** repeatedly, activate **Spotify (Spotify Connect)** mode.

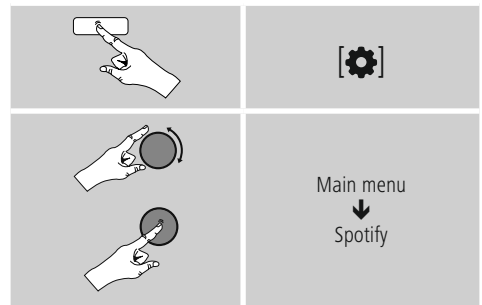

## 16. UNDOK – everything in the palm of your hand



Powered by  
**UNDOK**  
MULTIROOM

The UNDOK app, developed by Frontier Silicon, gives you full control of radios and speakers from your smartphone. Whether you are setting up the device for the first time, specifying settings for the equaliser and multi-room, or managing your favourite stations – the UNDOK app lets you access all the features from your smartphone or tablet, thereby offering you greater convenience.

### 16.1 Multi-room setup on the radio

#### 16.1.1 General information

- All radios must be connected to the same network via LAN cable or Wi-Fi.
- This section explains how multi-room can be set up on the devices and managed.
- A multi-room group can consist of up to five devices (one master and four clients).

#### Note

##### Master and client – explanation

- The master is the source device and transfers the audio it is currently playing to all other devices (clients) in the group.
- When playing audio via Bluetooth or from a CD, only the device that has the corresponding receiver or playback technology can be the master.

The following modes are available for a multi-room group (depending on whether the corresponding technology exists on the radio).

- **Spotify Connect**
- **Internet radio**
- **DAB radio**
- **FM radio**
- **Auxiliary Input**
- **Wi-Fi streaming (DNLA-compatible) and UPnP network playback**
- **USB playback**
- **CD playback**
- **Bluetooth**

#### 16.1.2 Creating a group

- If you want to create a new group, navigate to the system settings and select Multi-room. • Select Create new group.
- Enter a name for the new group and confirm with **[OK]**.

#### 16.1.3 View details

- Select this menu item to obtain information on the current status of the radio/speaker in the respective group.
- The Status field shows whether the selected device is a master or client.

#### 16.1.4 Add clients to a group

- If the selected device is already the master, you can add (further) clients using Add to group.
- On selecting this menu item, a list of the devices in the network is displayed. Devices with a preceding asterisk are already clients in the group.
- Only devices without an asterisk can be added as clients to the group.

#### 16.1.5 List current clients

- Select List current clients to display all members of the current group.



### 16.1.6 Leave group

- The Leave group menu item allows you to remove the client you are currently controlling from the current group.
- Confirm the client's removal from the group with **[OK]**.

### 16.1.7 Delete group

- If you want to delete a complete group, select 'Delete group'.
- Note that a group can be deleted only on the master of this group.

### 17. Care and Maintenance

- Only clean this product with a slightly damp, lint-free cloth and do not use aggressive cleaning agents.
- If you do not use the product for a long time, turn off the device and disconnect it from the power supply. Store it in a clean, dry place out of direct sunlight.

### 18. Warranty Disclaimer

Hama GmbH & Co KG assumes no liability and provides no warranty for damage resulting from improper installation/ mounting, improper use of the product or from failure to observe the operating instructions and/ or safety notes.

### 19. Service and Support

Please contact Hama Product Consulting if you have any questions about this product  
Hotline: +49 9091 502-115 (German/English)

Further support information can be found here:  
[www.hama.com](http://www.hama.com)

## 20. Recycling Information

### Note on environmental protection:



After the implementation of the European Directive 2012/19/EU and 2006/66/EU in the national legal system, the following applies: Electric and electronic devices as well as batteries must not be disposed of with household waste. Consumers are obliged by law to return electrical and electronic devices as well as batteries at the end of their service lives to the public collecting points set up for this purpose or point of sale. Details to this are defined by the national law of the respective country. This symbol on the product, the instruction manual or the package indicates that a product is subject to these regulations. By recycling, reusing the materials or other forms of utilising old devices/batteries, you are making an important contribution to protecting our environment.

## 21. Declaration of Conformity



Hereby, Hama GmbH & Co KG declares that the radio equipment type [00054844, 00054851] is in compliance with Directive 2014/53/EU. The full text of the EU declaration of conformity is available at the following internet address:

[www.hama.com](http://www.hama.com) -> 00054844, 00054851 -> Downloads

Frequency band(s)	WiFi: 2.412 - 2.472GHz WiFi: 5.150 - 5.350 GHz WiFi: 5.470 - 5.725 GHz
Maximum radio-frequency power transmitted	WiFi: 2.4GHz / 17dBm (EIRP) WiFi: 5GHz / 16.5dBm (EIRP)

### Restrictions or Requirements in

Belgium, Bulgaria, Czech Republic, Denmark, Germany, Estonia, Ireland, Greece, Spain, France, Croatia, Italy, Cyprus, Latvia, Lithuania, Luxembourg, Hungary, Malta, the Netherlands, Austria, Poland, Portugal, Romania, Slovenia, Slovakia, Finland, Sweden, United Kingdom



### Note

If channels 36–64 (frequency 5.150–5.350 GHz) are used in a 5-GHz WLAN, the product may only be used in closed rooms.



***hama***®

**Hama GmbH & Co KG**  
86652 Monheim/Germany  
[www.hama.com](http://www.hama.com)

**The Spotify software is subject to third party licenses found here:**  
**[www.spotify.com/connect/third-party-licenses](http://www.spotify.com/connect/third-party-licenses)**

All listed brands are trademarks of the corresponding companies. Errors and omissions excepted, and subject to technical changes. Our general terms of delivery and payment are applied.